



ODKVAPOVÝ SYSTÉM POLKRUHOVÝ



**CENNÍK
2023**



POWERFUL PARTNER FOR YOUR ROOF



Hliníkový materiál | 4



Žraby | 6



Dilatácie | 9



Žraby príslušenstvo | 13



Háky | 15



Rohy | 18



Čelá | 20



Kotlíky | 21



Kolená | 32



Zvodové rúry | 35



Zvodové rúry príslušenstvo | 40



Objímky | 42

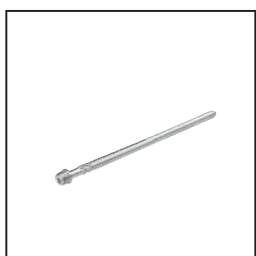

Objímky príslušenstvo | 43



Zachytávače vody | 45



Ochranné zvodové rúry | 48

ODKVAPOVÝ SYSTÉM POLKRUHOVÝ

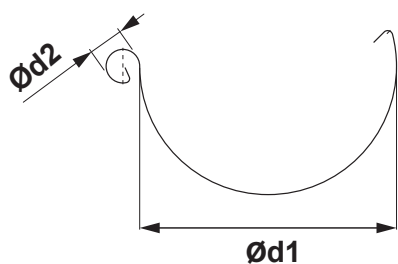

ROZMERY STREŠNÝCH ŽLABOV

(rozmery a rozmerové tolerancie podľa EN 612)

Rozvinutá šírka (mm)	200	250	280	333	400
Ød1	80	105	127	153	192
Ød2	16	18	18	20	22

VNÚTORNÝ FALZ

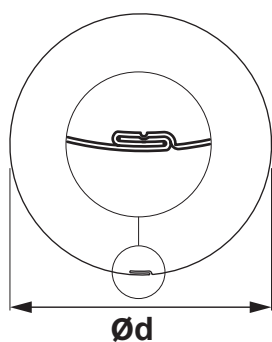

ROZMERY STREŠNÝCH ZVODOV

(rozmery a rozmerové tolerancie podľa EN 612)

Rozmery	60	80	100	120	150
Menovitá veľkosť Ød (mm)	60	80	100	120	150

ROZMERY STREŠNÝCH HÁKOV

(rozmery a rozmerové tolerancie podľa EN 612)

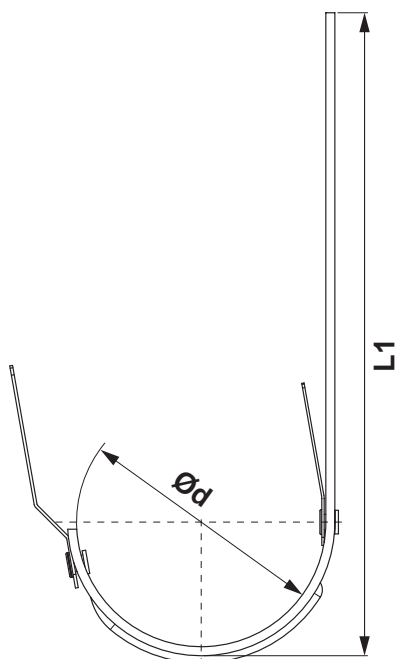

Rozmery (mm)	L1	Ød
200	290	80
250	310	105
280	345	127
333 – 550	385	153
333 – 610	445	153
400	400	192

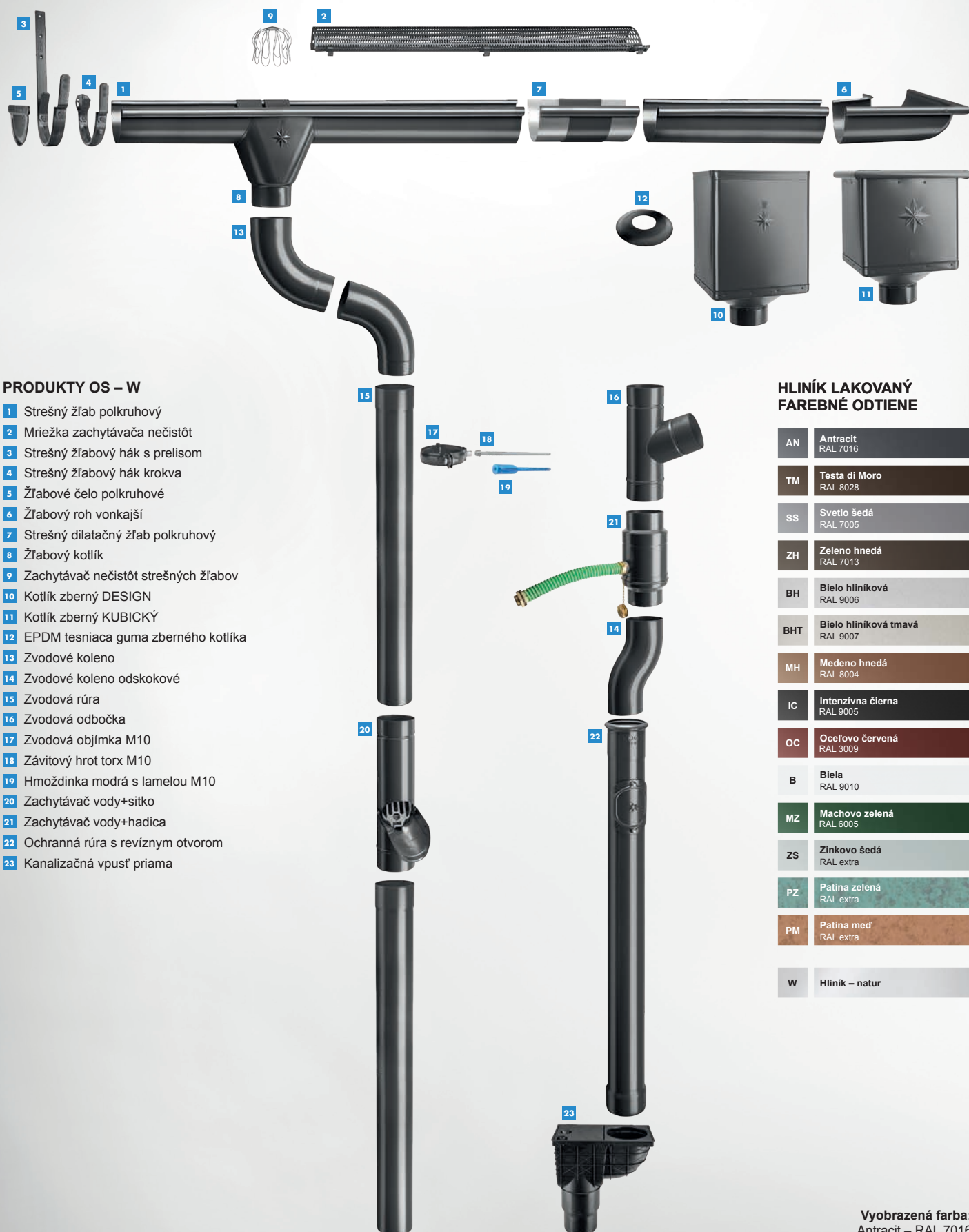

PRODUKTY OS – W

- 1 Strešný žľab polkruhový
- 2 Mriežka zachytávača nečistôt
- 3 Strešný žľabový hák s prelisom
- 4 Strešný žľabový hák krokva
- 5 Žľabové čelo polkruhové
- 6 Žľabový roh vonkajší
- 7 Strešný dilatčný žľab polkruhový
- 8 Žľabový kotlík
- 9 Zachytávač nečistôt strešných žľabov
- 10 Kotlík zberný DESIGN
- 11 Kotlík zberný KUBICKÝ
- 12 EPDM tesniaca guma zberného kotlíka
- 13 Zvodové koleno
- 14 Zvodové koleno odsokové
- 15 Zvodová rúra
- 16 Zvodová odbočka
- 17 Zvodová objímka M10
- 18 Závitový hrot torx M10
- 19 Hmoždinka modrá s lamelou M10
- 20 Zachytávač vody+sitko
- 21 Zachytávač vody+hadica
- 22 Ochranná rúra s revíznym otvorom
- 23 Kanalizačná vpusť priama

HLINÍK LAKOVANÝ FAREBNÉ ODTIENE

AN	Antracit RAL 7016
TM	Testa di Moro RAL 8028
SS	Svetlo šedá RAL 7005
ZH	Zeleno hnedá RAL 7013
BH	Bielo hliníková RAL 9006
BHT	Bielo hliníková tmavá RAL 9007
MH	Medeno hnedá RAL 8004
IC	Intenzívna čierna RAL 9005
OC	Oceľovo červená RAL 3009
B	Biela RAL 9010
MZ	Machovo zelená RAL 6005
ZS	Zinkovo šedá RAL extra
PZ	Patina zelená RAL extra
PM	Patina meď RAL extra
W	Hliník – natur



ALUMINIUM POLYESTER + NATUR

NOVELIS

Je americká priemyselná hliníková spoločnosť so sídlom v Atlante v štáte Georgia v Spojených štátoch. Je dcérskou spoločnosťou indickej spoločnosti na výrobu hliníka a medi Hindalco Industries. Novelis je popredným výrobcom valcovaného hliníka a globálnym lídrom v recyklácii nápojových plechoviek. Spoločnosť poskytuje služby zákazníkom v odvetviach vrátane plechoviek na nápoje, automobilového priemyslu, spotrebnej elektroniky, stavebníctva, fólií a obalov.

ADITYA BIRLA



SPEIRA

Speira je globálna spoločnosť na valcovanie a recykláciu hliníka. Skladá sa zo siedmich výrobných závodov a jedného výskumného a vývojového centra. Nachádzajúce sa v Nemecku a Nórsku vrátane nášho spoločného podniku Alunorf, najväčšej valcovne hliníka na svete, Grevenbroich, najväčšej dokončovacej valcovne hliníka na svete, ako aj niekoľkých medzinárodných predajných kancelárií. Speira zamestnáva okolo 5 000 ľudí hlavne v Nemecku a Nórsku

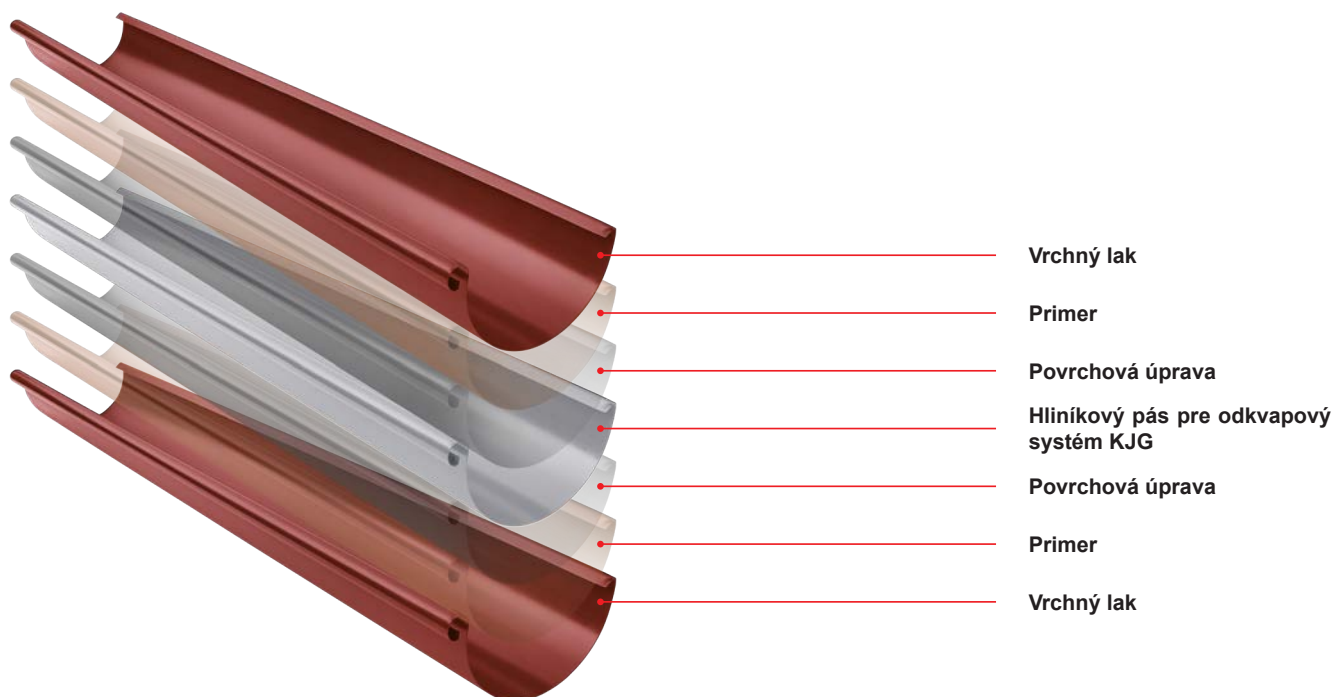

ALUMINIUM POLYESTER + NATUR

STREŠNÝ ŽĽAB POLKRUHOVÝ [s=0,70]

W-WZ

Menovitá veľkosť	200		250		250		280		280	
	3,0		4,0		6,0		4,0		6,0	
Dĺžka v m	3,0		4,0		6,0		4,0		6,0	
	Bez DPH	S DPH	Bez DPH	S DPH	Bez DPH	S DPH	Bez DPH	S DPH	Bez DPH	S DPH
AN 1 Antracit RAL 7016	6,40	7,68	5,20	6,24	5,20	6,24	6,65	7,98	6,65	7,98
	051066 *		051073		051080		051097		051103	
TM 2 Testa di Moro RAL 8028	6,40	7,68	5,20	6,24	5,20	6,24	6,65	7,98	6,65	7,98
	051707 *		051714		051721		051738		051745	
SS 3 Svetlo šedá RAL 7005			5,20	6,24	5,20	6,24	6,65	7,98	6,65	7,98
			051639		051646		051653		051660	
ZH 4 Zeleno hnedá RAL 7013			5,20	6,24	5,20	6,24	6,65	7,98	6,65	7,98
			051790		051806		051813		051820	
BH 5 Bielo hliníková RAL 9006			5,20	6,24	5,20	6,24	6,65	7,98	6,65	7,98
			051233		051240 *		051257		051264	
BHT 6 Bielo hliníková tmavá RAL 9007			5,20	6,24	5,20	6,24	6,65	7,98	6,65	7,98
			101891 *		101907 *		101914 *		101921 *	
MH 7 Medeno hnedá RAL 8004			5,20	6,24	5,20	6,24	6,65	7,98	6,65	7,98
			051394		051400		051417		051424	
IC 8 Intenzívna čierna RAL 9005			5,20	6,24	5,20	6,24	6,65	7,98	6,65	7,98
			051318		051325 *		051332		051349 *	
OC 9 Oceľovo červená RAL 3009			5,20	6,24	5,20	6,24	6,65	7,98	6,65	7,98
			051554		051561		051578		051585	
B 10 Biela RAL 9010			5,20	6,24	5,20	6,24	6,65	7,98	6,65	7,98
			051158		051165		051172		051189	
MZ 11 Machovo zelená RAL 6005			5,20	6,24	5,20	6,24	6,65	7,98	6,65	7,98
			051479		051486		051493		051509	
ZS 12 Zinkovo šedá RAL extra			5,20	6,24	5,20	6,24	6,65	7,98	6,65	7,98
			051875		051882 *		051899 *		051905 *	
PZ 13 Patina zelená RAL extra										
PM 14 Patina med RAL extra										
Hliník 15 Natur			4,70	5,64	4,70	5,64	5,40	6,48	5,40	6,48
			049957		049964		049971		049988	
Balenie v m	15		20		30		20		30	
Balenie v m	1 200		960		1 440		840		1 260	

* Výroba na objednávku



ALUMINIUM
POLYESTER + NATUR

STREŠNÝ ŽLAB POLKRUHOVÝ [s=0,70]

W-WZ



Menovitá veľkosť	333		333		400	
	Bez DPH	S DPH	Bez DPH	S DPH	Bez DPH	S DPH
Dĺžka v m	4,0		6,0		6,0	
Cena v €/m	Bez DPH	S DPH	Bez DPH	S DPH	Bez DPH	S DPH
AN 1 Antracit RAL 7016	6,80	8,16	6,80	8,16	9,90	11,88
	051110		051127		051134	
TM 2 Testa di Moro RAL 8028	6,80	8,16	6,80	8,16	9,90	11,88
	051752		051769		051776 *	
SS 3 Svetlo šedá RAL 7005	6,80	8,16	6,80	8,16	9,90	11,88
	051677		051684		051691	
ZH 4 Zeleno hnedá RAL 7013	6,80	8,16	6,80	8,16	9,90	11,88
	051837		051844		051851	
BH 5 Bielo hliníková RAL 9006	6,80	8,16	6,80	8,16	9,90	11,88
	051271		051288		051295	
BHT 6 Bielo hliníková tmavá RAL 9007	6,80	8,16	6,80	8,16	9,90	11,88
	101938		101945		070104 *	
MH 7 Medeno hnedá RAL 8004	6,80	8,16	6,80	8,16	9,90	11,88
	051431		051448		051455 *	
IC 8 Intenzívna čierna RAL 9005	6,80	8,16	6,80	8,16	9,90	11,88
	051356		051363		051370 *	
OC 9 Oceľovo červená RAL 3009	6,80	8,16	6,80	8,16	9,90	11,88
	051592		051608		051615 *	
B 10 Biela RAL 9010	6,80	8,16	6,80	8,16	9,90	11,88
	051196		051202		051219 *	
MZ 11 Machovo zelená RAL 6005	6,80	8,16	6,80	8,16	9,90	11,88
	051516		051523		051530	
ZS 12 Zinkovo šedá RAL extra	6,80	8,16	6,80	8,16	9,90	11,88
	051912		051929		051936 *	
PZ 13 Patina zelená RAL extra	9,00	10,80	9,00	10,80		
	112781 *		112798			
PM 14 Patina med RAL extra	9,00	10,80	9,00	10,80		
	112767 *		112774			
Hliník 15 Natur	6,05	7,26	6,05	7,26	8,10	9,72
	049995		050007		050014	
Balenie v m 	20		30		30	
Balenie v m 	660		990		810	

* Výroba na objednávku



NÁSTREŠNÝ ŽĽAB SAMRÍNOVÝ [s=0,70]

W-WZS



Menovitá veľkosť	650		700		700	
	Dĺžka v m		4,0		6,0	
Cena v €/m	Bez DPH	S DPH	Bez DPH	S DPH	Bez DPH	S DPH
	AN 1 Antracit RAL 7016			23,00	27,60	23,00
			049193		049209	
TM 2 Testa di Moro RAL 8028	18,00	21,60				
		049308 *				
SS 3 Svetlo šedá RAL 7005			23,00	27,60	23,00	27,60
			049285 *		049292	
ZH 4 Zeleno hnedá RAL 7013			23,00	27,60	23,00	27,60
			049315		049322	
BH 5 Bielo hliníková RAL 9006	18,00	21,60				
		049223 *				
BHT 6 Bielo hliníková tmavá RAL 9007	18,00	21,60				
		101990 *				
MH 7 Medeno hnedá RAL 8004	18,00	21,60				
		049247 *				
IC 8 Intenzívna čierna RAL 9005	18,00	21,60				
		049230 *				
OC 9 Oceľovo červená RAL 3009	18,00	21,60				
		049278 *				
B 10 Biela RAL 9010	18,00	21,60				
		049216 *				
MZ 11 Machovo zelená RAL 6005			23,00	27,60	23,00	27,60
			049254		049261	
ZS 12 Zinkovo šedá RAL extra	18,00	21,60				
		049339 *				
PZ 13 Patina zelená RAL extra						
PM 14 Patina med RAL extra						
Hliník 15 Natur	15,50	18,60				
		049186 *				
Balenie v m 	6		4		6	
Balenie v m 	300		200		300	

* Výroba na objednávku



STREŠNÝ DILATAČNÝ ŽLAB POLKRUHOVÝ

W-WZDI

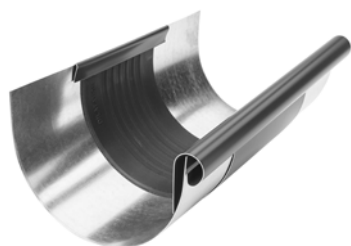

Menovitá veľkosť	250/260		285/260		333/260		400/260	
	Bez DPH	S DPH	Bez DPH	S DPH	Bez DPH	S DPH	Bez DPH	S DPH
AN 1 Antracit RAL 7016	20,50	24,60	21,50	25,80	21,50	25,80	27,00	32,40
	028341 *		028358 *		028365		028372	
TM 2 Testa di Moro RAL 8028	20,50	24,60	21,50	25,80	21,50	25,80	27,00	32,40
	028662 *		028679 *		028686		028693 *	
SS 3 Svetlo šedá RAL 7005	20,50	24,60	21,50	25,80	21,50	25,80	27,00	32,40
	028624 *		028631 *		028648 *		028655 *	
ZH 4 Zeleno hnedá RAL 7013	20,50	24,60	21,50	25,80	21,50	25,80	27,00	32,40
	028709 *		028716 *		028723 *		028730 *	
BH 5 Bielo hliníková RAL 9006	20,50	24,60	21,50	25,80	21,50	25,80	27,00	32,40
	028426 *		028433 *		028440		028457	
BHT 6 Bielo hliníková tmavá RAL 9007	20,50	24,60	21,50	25,80	21,50	25,80	27,00	32,40
	101440 *		101457 *		101464 *		070135 *	
MH 7 Medeno hnedá RAL 8004	20,50	24,60	21,50	25,80	21,50	25,80	27,00	32,40
	028501 *		028518 *		028525 *		028532 *	
IC 8 Intenzívna čierna RAL 9005	20,50	24,60	21,50	25,80	21,50	25,80	27,00	32,40
	028464 *		028471 *		028488 *		028495 *	
OC 9 Oceľovo červená RAL 3009	20,50	24,60	21,50	25,80	21,50	25,80	27,00	32,40
	028587 *		028594 *		028600 *		028617 *	
B 10 Biela RAL 9010	20,50	24,60	21,50	25,80	21,50	25,80	27,00	32,40
	028389 *		028396 *		028402 *		028419 *	
MZ 11 Machovo zelená RAL 6005	20,50	24,60	21,50	25,80	21,50	25,80	27,00	32,40
	028549 *		028556 *		028563 *		028570 *	
ZS 12 Zinkovo šedá RAL extra	20,50	24,60	21,50	25,80	21,50	25,80	27,00	32,40
	028747 *		028754 *		028761 *		028778 *	
PZ 13 Patina zelená RAL extra					32,50	39,00		
					112590 *			
PM 14 Patina meď RAL extra					32,50	39,00		
					112583 *			
Hliník 15 Natur	22,70	27,24	23,60	28,32	25,50	30,60	31,70	38,04
	028303 *		028310 *		028327 *		028334 *	
Balenie v ks 	3		3		5		5	
Balenie v ks 	360		360		200		200	

* Výroba na objednávku



DILATAČNÝ ŽĽAB NÁSTREŠNÝ – SAMRÍNA

W-WZSDI

Menovitá veľkosť	670/260	
Cena v €/ks	Bez DPH	S DPH
AN 1 Antracit RAL 7016	65,00	78,00
		029157 *
TM 2 Testa di Moro RAL 8028	65,00	78,00
		029232 *
SS 3 Svetlo šedá RAL 7005	65,00	78,00
		029225 *
ZH 4 Zeleno hnedá RAL 7013	65,00	78,00
		029249 *
BH 5 Bielo hliníková RAL 9006	65,00	78,00
		029171 *
BHT 6 Bielo hliníková tmavá RAL 9007	65,00	78,00
		101471 *
MH 7 Medeno hnedá RAL 8004	65,00	78,00
		029195 *
IC 8 Intenzívna čierna RAL 9005	65,00	78,00
		029188 *
OC 9 Oceľovo červená RAL 3009	65,00	78,00
		029218 *
B 10 Biela RAL 9010	65,00	78,00
		029164 *
MZ 11 Machovo zelená RAL 6005	65,00	78,00
		029201 *
ZS 12 Zinkovo šedá RAL extra	65,00	78,00
		029256 *
PZ 13 Patina zelená RAL extra		
PM 14 Patina meď RAL extra		
Hliník 15 Natur	58,50	70,20
		029140 *
Balenie v ks 		1
Balenie v ks 		40



* Výroba na objednávku





DILATAČNÝ PÁS

W-WZDIP

Menovitá veľkosť	Dĺžka v m	EAN číslo výrobku	Balenie v m		Cena [€/m]	
					Bez DPH	S DPH
260	3,0	028181	3	120	40,00	48,00

POUŽITIE DILATAČNÉHO ŽĽABU A DILATAČNÉHO PÁSU

DILATAČNÝ ŽĽAB

Príklad montáže: Pododkvapový žľab o rozvinutej šírke do 500 mm. Dilatačný žľab musí byť namontovaný v rozostupe 15 m. Pre vonkajší roh a začiatok žľabu platí polovica štandardnej hodnoty: maximálne 7,5 m. Pre vnútorný roh platí štvrtina štandardnej hodnoty: maximálne 3,75 m. Pre ostatné materiály a rozmery: pozri tabuľku nižšie. Rohy sa vždy počítajú ako pevné body.

DILATAČNÝ PÁS

Vnútorňa inštalácia: na žľaby uchytené bez lepenia na podklad, strechy s neštandardným profilom a oplechovania muriva

POLKRUHOVÉ DILATAČNÉ ŽĽABY

Rozvinutá šírka žľabu	Hliník	Pozink, Titán-zinok, Meď, Nerez
< 500	12	15
> 500	8	10

DILATAČNÝ PÁS

Rozvinutá šírka žľabu	Hliník	Pozink, Titán-zinok, Meď, Nerez
< 500	8	10
> 500	6	8

Pre vonkajší roh alebo začiatok žľabu platí polovica štandardnej hodnoty. Pre vnútorný roh platí jedna štvrtina štandardnej hodnoty.

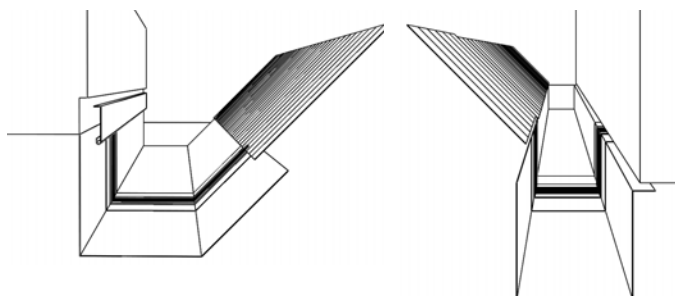
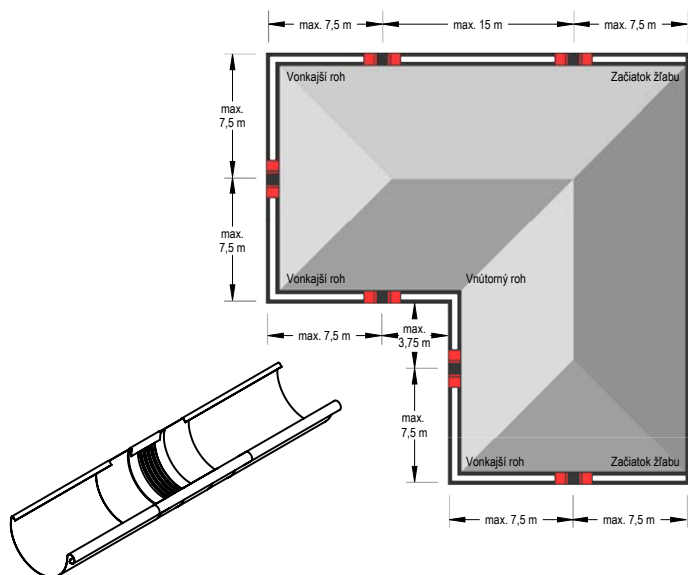

Poznámka k montáži dilatačného pásu.

Pri ohýbaní a montáži dilatačných prvkov sa uistite, že:



- Ohýbacie čeluste majú rádius minimálne 2 mm.
- Pre hrúbku plechu od 1 mm musí byť dodržaný polomer ohybu minimálne 5 mm.
- Ohýbacie čeluste musia byť pri ohýbaní nastavené na hrúbku strednej gumovej časti 3 až 4 mm, aby sa zabránilo strihaciemu efektu – poškodeniu gummy.
- Gumová stredná časť nesmie byť počas ohýbania stlačená alebo poškodená. Preto by mal byť použitý hliníkový plechový pás 2 až 5 mm (hrubý) ohnutý tak, aby mohol byť pripevnený ako ochrana na ohýbacie čeluste. Tým sa dosiahne väčší polomer ohybu a zabráni sa porušeniu gumovej strednej časti.

Poznámka k montáži dilatačného žľabu.

Pri montáži pomocou spájkovania najprv stredný gumový diel prekryte mokrou handričkou (aby nedošlo k prestupu tepla do stredného gumového dielu). Musí sa dodržať minimálna vzdialenosť 6 cm od strednej gumovej časti. V každom prípade sa treba vyhýbať kontaktu gummy s otvoreným plameňom.

MRIEŽKA ZACHYTÁVAČA NEČISTÔT

W-WZNLM

Menovitá veľkosť	333	
Dĺžka v m	2,0	
Cena v €/ks	Bez DPH	S DPH
AN 1 Antracit RAL 7016	26,50	31,80
	064950	
TM 2 Testa di Moro RAL 8028	26,50	31,80
	064981 *	
SS 3 Svetlo šedá RAL 7005	26,50	31,80
	064974	
ZH 4 Zeleno hnedá RAL 7013	26,50	31,80
	118127 *	
BH 5 Bielo hliníková RAL 9006	26,50	31,80
	118080 *	
BHT 6 Bielo hliníková tmavá RAL 9007	26,50	31,80
	118097 *	
MH 7 Medeno hnedá RAL 8004	26,50	31,80
	118103 *	
IC 8 Intenzívna čierna RAL 9005	26,50	31,80
	118059	
OC 9 Oceľovo červená RAL 3009	26,50	31,80
	118066 *	
B 10 Biela RAL 9010	26,50	31,80
	118134 *	
MZ 11 Machovo zelená RAL 6005	26,50	31,80
	118110 *	
ZS 12 Zinkovo šedá RAL extra	26,50	31,80
	118073 *	
PZ 13 Patina zelená RAL extra		
PM 14 Patina med RAL extra		
Hliník 15 Natur	25,50	30,60
	064905	
Balenie v ks 	15	
Balenie v ks 	120	

* Výroba na objednávku

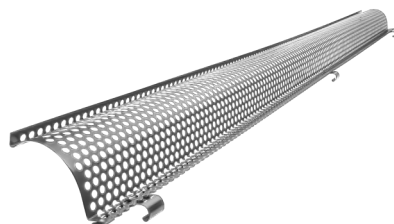



ALUMINIUM POLYESTER + NATUR

PVC MRIEŽKA ZACHYTÁVAČA LÍSTIA

SD-ZNL MRIEŽKA

Menovitá veľkosť	Dĺžka v m	EAN číslo výrobku	Balenie v ks		Cena [€/ks]	
					Bez DPH	S DPH
PS 171	1,0	008473	30	450	4,50	5,40
TM 171	1,0	008466	30	450	4,50	5,40

PVC MRIEŽKA ZACHYTÁVAČA LÍSTIA

SD-ZNL N

Menovitá veľkosť	Dĺžka v m	EAN číslo výrobku	Balenie v ks		Cena [€/ks]	
					Bez DPH	S DPH
250	3,0	008480	10	400	23,90	28,68
280-333	3,0	008497	10	400	24,00	28,80

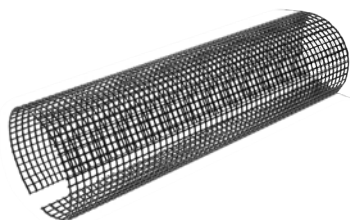
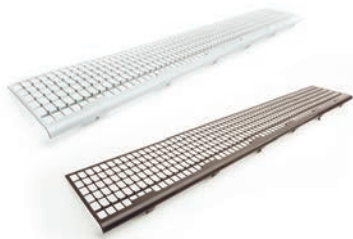

STREŠNÝ ŽLABOVÝ HÁK S PRELISOM
W-WHP

Menovitá veľkosť	250/430		280/480		333/550		333/650		400/650		
	23/7		28/7		28/7		28/7		30/7		
Materiál											
Cena v €/ks	Bez DPH	S DPH	Bez DPH	S DPH	Bez DPH	S DPH	Bez DPH	S DPH	Bez DPH	S DPH	
AN Antracit RAL 7016	1	3,40	4,08	3,90	4,68	4,30	5,16	4,90	5,88	5,20	6,24
		077615	077622	077639	077646	077653					
TM Testa di Moro RAL 8028	2	3,40	4,08	3,90	4,68	4,30	5,16	4,90	5,88	5,20	6,24
		078018	078025	078032	078049	078056					
SS Svetlo šedá RAL 7005	3	3,40	4,08	3,90	4,68	4,30	5,16	4,90	5,88	5,20	6,24
		077967	077974	077981	077998	078001					
ZH Zeleno hnedá RAL 7013	4	3,40	4,08	3,90	4,68	4,30	5,16	4,90	5,88	5,20	6,24
		078063	078070	078117	078087	078094					
BH Bielo hliníková RAL 9006	5	3,40	4,08	3,90	4,68	4,30	5,16	4,90	5,88	5,20	6,24
		077714	077738	077721	077745 *	077752					
BHT Bielo hliníková tmavá RAL 9007	6	3,40	4,08	3,90	4,68	4,30	5,16	4,90	5,88	5,20	6,24
		101488 *	101495 *	101501	101518 *	080264 *					
MH Medeno hnedá RAL 8004	7	3,40	4,08	3,90	4,68	4,30	5,16	4,90	5,88	5,20	6,24
		077813	077820	077837	077844 *	077851					
IC Intenzívna čierna RAL 9005	8	3,40	4,08	3,90	4,68	4,30	5,16	4,90	5,88	5,20	6,24
		077769	077776	077783	077790 *	077806					
OC Oceľovo červená RAL 3009	9	3,40	4,08	3,90	4,68	4,30	5,16	4,90	5,88	5,20	6,24
		077912	077929	077936	077943 *	077950					
B Biela RAL 9010	10	3,40	4,08	3,90	4,68	4,30	5,16	4,90	5,88	5,20	6,24
		077660	077677	077684	077691 *	077707					
MZ Machovo zelená RAL 6005	11	3,40	4,08	3,90	4,68	4,30	5,16	4,90	5,88	5,20	6,24
		077868	077899	077875	077882	077905					
ZS Zinkovo šedá RAL extra	12	3,40	4,08	3,90	4,68	4,30	5,16	4,90	5,88	5,20	6,24
		078124	078100	078131	078148 *	078155 *					
PZ Patina zelená RAL extra	13				9,00	10,80					
					112613						
PM Patina med RAL extra	14				9,00	10,80					
					112606						
Hliník Natur	15	3,05	3,66	3,50	4,20	3,85	4,62	4,40	5,28	4,70	5,64
		011930	011947	077585	077592	077608					
Balenie v ks		25		25		25		15		20	
Balenie v ks		1 000		1 000		1 000		600		800	

* Výroba na objednávku



STREŠNÝ ŽLABOVÝ HÁK KROKVA
W-WHPK



Menovitá veľkosť	250		280		333	
	28/7		28/7		28/7	
Materiál	28/7		28/7		28/7	
Cena v €/ks	Bez DPH	S DPH	Bez DPH	S DPH	Bez DPH	S DPH
AN Antracit RAL 7016	3,85	4,62	3,90	4,68	3,95	4,74
	011596		011602		011619	
TM Testa di Moro RAL 8028	3,85	4,62	3,90	4,68	3,95	4,74
	011831		011848		011855	
SS Svetlo šedá RAL 7005	3,85	4,62	3,90	4,68	3,95	4,74
	011800		011817 *		011824	
ZH Zeleno hnedá RAL 7013	3,85	4,62	3,90	4,68	3,95	4,74
	011862		011879		011886	
BH Bielo hliníková RAL 9006	3,85	4,62	3,90	4,68	3,95	4,74
	011657		011664		011671	
BHT Bielo hliníková tmavá RAL 9007	3,85	4,62	3,90	4,68	3,95	4,74
	101402 *		101396 *		101389 *	
MH Medeno hnedá RAL 8004	3,85	4,62	3,90	4,68	3,95	4,74
	011718		011725 *		011732	
IC Intenzívna čierna RAL 9005	3,85	4,62	3,90	4,68	3,95	4,74
	011688		011695 *		011701	
OC Oceľovo červená RAL 3009	3,85	4,62	3,90	4,68	3,95	4,74
	011770 *		011787 *		011794	
B Biela RAL 9010	3,85	4,62	3,90	4,68	3,95	4,74
	011626		011633		011640	
MZ Machovo zelená RAL 6005	3,85	4,62	3,90	4,68	3,95	4,74
	011749		011756		011763	
ZS Zinkovo šedá RAL extra	3,85	4,62	3,90	4,68	3,95	4,74
	011893 *		011909 *		011916 *	
PZ Patina zelená RAL extra						
PM Patina med RAL extra						
Hliník Natur	3,45	4,14	3,50	4,20	3,55	4,26
	011565		011572		011589	
Balenie v ks	25		25		25	
Balenie v ks	1 000		1 000		1 000	

* Výroba na objednávku



NÁSTREŠNÝ HÁK SAMRÍNOVÝ SPEVNENÝ

W-WHSG



Menovitá veľkosť	4	
Materiál	28/7	
Cena v €/ks	Bez DPH	S DPH
AN 1 Antracit RAL 7016	8,95	10,74
	034113	
TM 2 Testa di Moro RAL 8028	8,95	10,74
	034199 *	
SS 3 Svetlo šedá RAL 7005	8,95	10,74
	034182	
ZH 4 Zeleno hnedá RAL 7013	8,95	10,74
	034205	
BH 5 Bielo hliníková RAL 9006	8,95	10,74
	034137	
BHT 6 Bielo hliníková tmavá RAL 9007	8,95	10,74
	101525 *	
MH 7 Medeno hnedá RAL 8004	8,95	10,74
	034151	
IC 8 Intenzívna čierna RAL 9005	8,95	10,74
	034144 *	
OC 9 Oceľovo červená RAL 3009	8,95	10,74
	034175 *	
B 10 Biela RAL 9010	8,95	10,74
	034120 *	
MZ 11 Machovo zelená RAL 6005	8,95	10,74
	034168	
ZS 12 Zinkovo šedá RAL extra	8,95	10,74
	034212 *	
PZ 13 Patina zelená RAL extra		
PM 14 Patina med RAL extra		
Hliník 15 Natur	8,05	9,66
	034229 *	
Balenie v ks 	15	
Balenie v ks 	600	

* Výroba na objednávku



ŽLABOVÝ ROH VONKAJŠÍ

W-WRA



Menovitá veľkosť	200		250		280		333		400	
	Bez DPH	S DPH	Bez DPH	S DPH	Bez DPH	S DPH	Bez DPH	S DPH	Bez DPH	S DPH
AN 1 Antracit RAL 7016			14,80	17,76	15,50	18,60	16,20	19,44	29,00	34,80
			082220		082237		082244		082251	
TM 2 Testa di Moro RAL 8028			14,80	17,76	15,50	18,60	16,20	19,44	29,00	34,80
			082541		082558		082565		082572 *	
SS 3 Svetlo šedá RAL 7005			14,80	17,76	15,50	18,60	16,20	19,44	29,00	34,80
			082503		082510		082527		082534	
ZH 4 Zeleno hnedá RAL 7013			14,80	17,76	15,50	18,60	16,20	19,44	29,00	34,80
			082589		082596		082602		082619 *	
BH 5 Bielo hliníková RAL 9006			14,80	17,76	15,50	18,60	16,20	19,44	29,00	34,80
			082305		082312 *		082329		082336 *	
BHT 6 Bielo hliníková tmavá RAL 9007			14,80	17,76	15,50	18,60	16,20	19,44	29,00	34,80
			101839 *		101846 *		101853		080295 *	
MH 7 Medeno hnedá RAL 8004			14,80	17,76	15,50	18,60	16,20	19,44	29,00	34,80
			082381		082398		082404		082411 *	
IC 8 Intenzívna čierna RAL 9005			14,80	17,76	15,50	18,60	16,20	19,44	29,00	34,80
			082343		082350		082367		082374 *	
OC 9 Oceľovo červená RAL 3009			14,80	17,76	15,50	18,60	16,20	19,44	29,00	34,80
			082466		082473		082480		082497 *	
B 10 Biela RAL 9010			14,80	17,76	15,50	18,60	16,20	19,44	29,00	34,80
			082268		082275		082282		082299 *	
MZ 11 Machovo zelená RAL 6005			14,80	17,76	15,50	18,60	16,20	19,44	29,00	34,80
			082428		082435		082442		082459 *	
ZS 12 Zinkovo šedá RAL extra			14,80	17,76	15,50	18,60	16,20	19,44	29,00	34,80
			082626		082633		082640		082657 *	
PZ 13 Patina zelená RAL extra							17,70	21,24		
							112736			
PM 14 Patina meď RAL extra							17,70	21,24		
							112729			
Hliník 15 Natur	13,30	15,96	13,30	15,96	13,95	16,74	14,60	17,52	26,10	31,32
			000514 *		000521		000538		000545	000552 *
Balenie v ks 	5		5		5		5		5	
Balenie v ks 	150		150		150		150		150	

* Výroba na objednávku



ŽLABOVÝ ROH VNÚTORNÝ

W-WRI



Menovitá veľkosť	200		250		280		333		400	
	Bez DPH	S DPH	Bez DPH	S DPH	Bez DPH	S DPH	Bez DPH	S DPH	Bez DPH	S DPH
AN 1 Antracit RAL 7016			14,80	17,76	15,50	18,60	16,20	19,44	29,00	34,80
			081780		081797		081803		081810	
TM 2 Testa di Moro RAL 8028			14,80	17,76	15,50	18,60	16,20	19,44	29,00	34,80
			082107		082114		082121		082138	
SS 3 Svetlo šedá RAL 7005			14,80	17,76	15,50	18,60	16,20	19,44	29,00	34,80
			082060		082077		082084		082091 *	
ZH 4 Zeleno hnedá RAL 7013			14,80	17,76	15,50	18,60	16,20	19,44	29,00	34,80
			082145		082152		082169		082176 *	
BH 5 Bielo hliníková RAL 9006			14,80	17,76	15,50	18,60	16,20	19,44	29,00	34,80
			081865 *		081872 *		081889		081896 *	
BHT 6 Bielo hliníková tmavá RAL 9007			14,80	17,76	15,50	18,60	16,20	19,44	29,00	34,80
			101860 *		101877 *		101884		069221 *	
MH 7 Medeno hnedá RAL 8004			14,80	17,76	15,50	18,60	16,20	19,44	29,00	34,80
			081940		081957		081964		081971 *	
IC 8 Intenzívna čierna RAL 9005			14,80	17,76	15,50	18,60	16,20	19,44	29,00	34,80
			081902		081919		081926		081933 *	
OC 9 Oceľovo červená RAL 3009			14,80	17,76	15,50	18,60	16,20	19,44	29,00	34,80
			082022		082039		082046		082053 *	
B 10 Biela RAL 9010			14,80	17,76	15,50	18,60	16,20	19,44	29,00	34,80
			081827		081834		081841		081858 *	
MZ 11 Machovo zelená RAL 6005			14,80	17,76	15,50	18,60	16,20	19,44	29,00	34,80
			081988		081995		082008		082015 *	
ZS 12 Zinkovo šedá RAL extra			14,80	17,76	15,50	18,60	16,20	19,44	29,00	34,80
			082183		082190		082206		082213 *	
PZ 13 Patina zelená RAL extra							17,70	21,24		
							112750			
PM 14 Patina meď RAL extra							17,70	21,24		
							112743			
Hliník 15 Natur	13,30	15,96	13,30	15,96	13,95	16,74	14,60	17,52	26,10	31,32
			000569 *		000576 *		000583 *		000590 *	000606 *
Balenie v ks 	5		5		5		5		5	
Balenie v ks 	150		150		150		150		150	

* Výroba na objednávku



ŽLABOVÉ ČELO POLKRUHOVÉ

W-WCL



Menovitá veľkosť	200		250		280		333		400	
	Bez DPH	S DPH	Bez DPH	S DPH	Bez DPH	S DPH	Bez DPH	S DPH	Bez DPH	S DPH
AN 1 Antracit RAL 7016	1,50	1,80	1,50	1,80	1,55	1,86	1,60	1,92	2,40	2,88
	085856 *		085863		085870		085887		085894	
TM 2 Testa di Moro RAL 8028	1,50	1,80	1,50	1,80	1,55	1,86	1,60	1,92	2,40	2,88
	086228 *		086235		086242		086259		086266	
SS 3 Svetlo šedá RAL 7005			1,50	1,80	1,55	1,86	1,60	1,92	2,40	2,88
			086181		086198		086204		086211	
ZH 4 Zeleno hnedá RAL 7013			1,50	1,80	1,55	1,86	1,60	1,92	2,40	2,88
			086273		086280		086297		086303	
BH 5 Bielo hliníková RAL 9006			1,50	1,80	1,55	1,86	1,60	1,92	2,40	2,88
			085948		085955		085962		085979	
BHT 6 Bielo hliníková tmavá RAL 9007			1,50	1,80	1,55	1,86	1,60	1,92	2,40	2,88
			101419 *		101426 *		101433		080257 *	
MH 7 Medeno hnedá RAL 8004			1,50	1,80	1,55	1,86	1,60	1,92	2,40	2,88
			086020		086037		086044		086051	
IC 8 Intenzívna čierna RAL 9005			1,50	1,80	1,55	1,86	1,60	1,92	2,40	2,88
			085986		085993		086006		086013 *	
OC 9 Oceľovo červená RAL 3009			1,50	1,80	1,55	1,86	1,60	1,92	2,40	2,88
			086105		086112		086129		086136	
B 10 Biela RAL 9010			1,50	1,80	1,55	1,86	1,60	1,92	2,40	2,88
			085900		085917		085924		085931 *	
MZ 11 Machovo zelená RAL 6005			1,50	1,80	1,55	1,86	1,60	1,92	2,40	2,88
			086068		086075		086082		086099 *	
ZS 12 Zinkovo šedá RAL extra			1,50	1,80	1,55	1,86	1,60	1,92	2,40	2,88
			086310		086327 *		086334		086341 *	
PZ 13 Patina zelená RAL extra							4,00	4,80		
							086174			
PM 14 Patina meď RAL extra							4,00	4,80		
							086150			
Hliník 15 Natur			1,35	1,62	1,40	1,68	1,45	1,74	2,15	2,58
			085818		085825		085832		085849	
Balenie v ks 	6/60		6/60		6/60		6/60		4/40	
Balenie v ks 	1 440		1 440		1 440		1 440		960	

* Výroba na objednávku



ŽLABOVÝ KOTLÍK

W-WKL



Menovitá veľkosť	200/60		250/60		250/80		280/80		280/100	
	Bez DPH	S DPH	Bez DPH	S DPH	Bez DPH	S DPH	Bez DPH	S DPH	Bez DPH	S DPH
AN 1 Antracit RAL 7016	10,00	12,00	10,60	12,72	11,30	13,56	13,00	15,60	12,50	15,00
	078278		078285		078292		078308		078315	
TM 2 Testa di Moro RAL 8028	10,00	12,00	10,60	12,72	11,30	13,56	13,00	15,60	12,50	15,00
	079152		079169		079176		079183		079190	
SS 3 Svetlo šedá RAL 7005	10,00	12,00	10,60	12,72	11,30	13,56	13,00	15,60	12,50	15,00
	079046 *		079053 *		079060		079077		079084	
ZH 4 Zeleno hnedá RAL 7013	10,00	12,00	10,60	12,72	11,30	13,56	13,00	15,60	12,50	15,00
	079268 *		079275		079282		079299		079305	
BH 5 Bielo hliníková RAL 9006	10,00	12,00	10,60	12,72	11,30	13,56	13,00	15,60	12,50	15,00
	078490 *		078506 *		078513		078520		078537	
BHT 6 Bielo hliníková tmavá RAL 9007					11,30	13,56	13,00	15,60	12,50	15,00
					101594		101600 *		101617 *	
MH 7 Medeno hnedá RAL 8004	10,00	12,00	10,60	12,72	11,30	13,56	13,00	15,60	12,50	15,00
	078711 *		078728 *		078735		078742		078759	
IC 8 Intenzívna čierna RAL 9005	10,00	12,00	10,60	12,72	11,30	13,56	13,00	15,60	12,50	15,00
	078605 *		078612 *		078629		078636		078643	
OC 9 Oceľovo červená RAL 3009	10,00	12,00	10,60	12,72	11,30	13,56	13,00	15,60	12,50	15,00
	078964 *		078933 *		078940		078957		078971	
B 10 Biela RAL 9010	10,00	12,00	10,60	12,72	11,30	13,56	13,00	15,60	12,50	15,00
	078384 *		078391 *		078407		078414		078421	
MZ 11 Machovo zelená RAL 6005	10,00	12,00	10,60	12,72	11,30	13,56	13,00	15,60	12,50	15,00
	078827 *		078834 *		078841		078858		078865	
ZS 12 Zinkovo šedá RAL extra	10,00	12,00	10,60	12,72	11,30	13,56	13,00	15,60	12,50	15,00
	079374 *		079381 *		079398		079404		079411	
PZ 13 Patina zelená RAL extra										
PM 14 Patina meď RAL extra										
Hliník 15 Natur	9,00	10,80	9,55	11,46	10,20	12,24	11,70	14,04	11,25	13,50
	078162 *		078179 *		078186		078193		078223	
Balenie v ks 	20		20		20		20		20	
Balenie v ks 	600		600		600		600		600	

* Výroba na objednávku



ŽLABOVÝ KOTLÍK

W-WKL



Menovitá veľkosť	333/80		333/100		333/120	
	Bez DPH	S DPH	Bez DPH	S DPH	Bez DPH	S DPH
AN 1 Antracit RAL 7016	13,40	16,08	13,70	16,44	18,00	21,60
	078322		078339		078346	
TM 2 Testa di Moro RAL 8028	13,40	16,08	13,70	16,44	18,00	21,60
	079206		079213		079220	
SS 3 Svetlo šedá RAL 7005	13,40	16,08	13,70	16,44	18,00	21,60
	079091 *		079107		079114	
ZH 4 Zeleno hnedá RAL 7013	13,40	16,08	13,70	16,44	18,00	21,60
	079312 *		079336		079329	
BH 5 Bielo hliníková RAL 9006	13,40	16,08	13,70	16,44	18,00	21,60
	078544		078551		078568	
BHT 6 Bielo hliníková tmavá RAL 9007	13,40	16,08	13,70	16,44	18,00	21,60
	101624 *		101631		101648 *	
MH 7 Medeno hnedá RAL 8004	13,40	16,08	13,70	16,44	18,00	21,60
	078766 *		078773		078780	
IC 8 Intenzívna čierna RAL 9005	13,40	16,08	13,70	16,44	18,00	21,60
	078650 *		078667		078674	
OC 9 Oceľovo červená RAL 3009	13,40	16,08	13,70	16,44	18,00	21,60
	078988 *		078995		079015	
B 10 Biela RAL 9010	13,40	16,08	13,70	16,44	18,00	21,60
	078438		078445		078452	
MZ 11 Machovo zelená RAL 6005	13,40	16,08	13,70	16,44	18,00	21,60
	078872 *		078889		078896	
ZS 12 Zinkovo šedá RAL extra	13,40	16,08	13,70	16,44	18,00	21,60
	079428 *		079435		079442	
PZ 13 Patina zelená RAL extra			19,20	23,04		
			112675			
PM 14 Patina meď RAL extra			19,20	23,04		
			112668			
Hliník 15 Natur	12,05	14,46	12,35	14,82	16,20	19,44
	078209		078230		078216	
Balenie v ks 	20		20		15	
Balenie v ks 	600		600		300	

* Výroba na objednávku



ŽLABOVÝ KOTLÍK

W-WKL

Menovitá veľkosť	400/100		400/120		400/150	
	Bez DPH	S DPH	Bez DPH	S DPH	Bez DPH	S DPH
AN 1 Antracit RAL 7016	18,70	22,44	20,00	24,00	35,00	42,00
	078353 *		078360		078377 *	
TM 2 Testa di Moro RAL 8028	18,70	22,44	20,00	24,00	35,00	42,00
	079237 *		079244		079251 *	
SS 3 Svetlo šedá RAL 7005	18,70	22,44	20,00	24,00	35,00	42,00
	079121 *		079138		079145 *	
ZH 4 Zeleno hnedá RAL 7013	18,70	22,44	20,00	24,00	35,00	42,00
	079343 *		079350		079367	
BH 5 Bielo hliníková RAL 9006	18,70	22,44	20,00	24,00	35,00	42,00
	078575 *		078582		078599 *	
BHT 6 Bielo hliníková tmavá RAL 9007			20,00	24,00		
			080288 *			
MH 7 Medeno hnedá RAL 8004	18,70	22,44	20,00	24,00	35,00	42,00
	078797 *		078803		078810 *	
IC 8 Intenzívna čierna RAL 9005	18,70	22,44	20,00	24,00	35,00	42,00
	078681 *		078698		078704 *	
OC 9 Oceľovo červená RAL 3009	18,70	22,44	20,00	24,00	35,00	42,00
	079008 *		079022 *		079039 *	
B 10 Biela RAL 9010	18,70	22,44	20,00	24,00	35,00	42,00
	078469 *		078476		078483 *	
MZ 11 Machovo zelená RAL 6005	18,70	22,44	20,00	24,00	35,00	42,00
	078902 *		078919		078926 *	
ZS 12 Zinkovo šedá RAL extra	18,70	22,44	20,00	24,00	35,00	42,00
	079459 *		079466		079473 *	
PZ 13 Patina zelená RAL extra						
PM 14 Patina meď RAL extra						
Hliník 15 Natur	16,85	20,22	18,00	21,60	31,50	37,80
	078247 *		078254		078261 *	
Balenie v ks 		15		15		15
Balenie v ks 		300		300		300

* Výroba na objednávku



NOVÝ
UPINACÍ SYSTÉM
FEDER UMOŽŇUJE
LAHKO NATAČIŤ KOLENO
DO POŽADOVANÉHO SMERU
A SPOLIAHLIVO DRŽÍ V KAŽDEJ
POLOHE. LAHKÁ MONTÁŽ
NA AKÉKOLVEK
KOLENO BEZ
NITOVANIA.



1



2



3



ALUMINIUM
POLYESTER + NATUR



NEREZOVÝ ZACHYTÁVAČ NEČISTÔT STREŠNÝCH ŽLABOV

N-NZN





Menovitá veľkosť	EAN číslo výrobku	Balenie v ks		Cena [€/ks]	
				Bez DPH	S DPH
60	001153	30	2 160	5,55	6,66
80	001160	20	1 440	5,60	6,72
100	001177	15	1 080	5,70	6,84
120	001184	10	720	6,20	7,44
150	001191	5	360	9,80	11,76



KOTLÍK ZBERNÝ DESIGN

W-WKLZ DE

Menovitá veľkosť	80		100		120	
	Bez DPH	S DPH	Bez DPH	S DPH	Bez DPH	S DPH
AN 1 Antracit RAL 7016	99,90	119,88	99,90	119,88	105,00	126,00
	031044 *		031068		031082 *	
TM 2 Testa di Moro RAL 8028	99,90	119,88	99,90	119,88	105,00	126,00
	032249 *		032263		032287 *	
SS 3 Svetlo šedá RAL 7005	99,90	119,88	99,90	119,88	105,00	126,00
	032096 *		032119		032133 *	
ZH 4 Zeleno hnedá RAL 7013	99,90	119,88	99,90	119,88	105,00	126,00
	032393 *		032416		032430 *	
BH 5 Bielo hliníková RAL 9006	99,90	119,88	99,90	119,88	105,00	126,00
	031341 *		031365		031389 *	
BHT 6 Bielo hliníková tmavá RAL 9007						
MH 7 Medeno hnedá RAL 8004	99,90	119,88	99,90	119,88	105,00	126,00
	031648 *		031662 *		031686 *	
IC 8 Intenzívna čierna RAL 9005	99,90	119,88	99,90	119,88	105,00	126,00
	031495 *		031518		031532 *	
OC 9 Oceľovo červená RAL 3009	99,90	119,88	99,90	119,88	105,00	126,00
	031945 *		031969 *		031983 *	
B 10 Biela RAL 9010	99,90	119,88	99,90	119,88	105,00	126,00
	031198 *		031211		031235 *	
MZ 11 Machovo zelená RAL 6005	99,90	119,88	99,90	119,88	105,00	126,00
	031792 *		031815 *		031839 *	
ZS 12 Zinkovo šedá RAL extra	99,90	119,88	99,90	119,88	105,00	126,00
	032546 *		032560 *		032584 *	
PZ 13 Patina zelená RAL extra						
PM 14 Patina meď RAL extra						
Hliník 15 Natur	89,90	107,88	89,90	107,88	94,50	113,40
	030894 *		030917 *		030931 *	
Balenie v ks 	2		2		2	
Balenie v ks 	36		36		36	



* Výroba na objednávku



KOTLÍK ZBERNÝ DESING EXZENTRICKÝ

W-WKLZ DX





Menovitá veľkosť	80		100		120	
	Bez DPH	S DPH	Bez DPH	S DPH	Bez DPH	S DPH
AN 1 Antracit RAL 7016	115,00	138,00	115,00	138,00	125,00	150,00
	031105 *		031136		031167	
TM 2 Testa di Moro RAL 8028	115,00	138,00	115,00	138,00	125,00	150,00
	032300 *		032331 *		032362 *	
SS 3 Svetlo šedá RAL 7005	115,00	138,00	115,00	138,00	125,00	150,00
	032157		032188		032218 *	
ZH 4 Zeleno hnedá RAL 7013	115,00	138,00	115,00	138,00	125,00	150,00
	032454 *		032485 *		032515 *	
BH 5 Bielo hliníková RAL 9006	115,00	138,00	115,00	138,00	125,00	150,00
	031402 *		031433 *		031464 *	
BHT 6 Bielo hliníková tmavá RAL 9007	115,00	138,00	115,00	138,00	125,00	150,00
	101655 *		101679 *		101693 *	
MH 7 Medeno hnedá RAL 8004	115,00	138,00	115,00	138,00	125,00	150,00
	031709 *		031730 *		031761 *	
IC 8 Intenzívna čierna RAL 9005	115,00	138,00	115,00	138,00	125,00	150,00
	031556 *		031587 *		031617 *	
OC 9 Oceľovo červená RAL 3009	115,00	138,00	115,00	138,00	125,00	150,00
	032003 *		032034 *		032065 *	
B 10 Biela RAL 9010	115,00	138,00	115,00	138,00	125,00	150,00
	031259 *		031280 *		031310 *	
MZ 11 Machovo zelená RAL 6005	115,00	138,00	115,00	138,00	125,00	150,00
	031853 *		031884 *		031914 *	
ZS 12 Zinkovo šedá RAL extra	115,00	138,00	115,00	138,00	125,00	150,00
	032607 *		032638 *		032669 *	
PZ 13 Patina zelená RAL extra						
PM 14 Patina meď RAL extra						
Hliník 15 Natur	103,50	124,20	110,00	132,00	112,50	135,00
	030955 *		030986 *		031013 *	
Balenie v ks 	2		2		2	
Balenie v ks 	36		36		36	

* Výroba na objednávku

KOTLÍK ZBERNÝ KUBICKÝ

W-WKLZ KU



Menovitá veľkosť	80		100		120	
	Bez DPH	S DPH	Bez DPH	S DPH	Bez DPH	S DPH
AN 1 Antracit RAL 7016	128,00	153,60	128,00	153,60	145,00	174,00
	031051 *		031075		031099 *	
TM 2 Testa di Moro RAL 8028	128,00	153,60	128,00	153,60	145,00	174,00
	032256 *		032270 *		032294 *	
SS 3 Svetlo šedá RAL 7005	128,00	153,60	128,00	153,60	145,00	174,00
	032102 *		032126 *		032140 *	
ZH 4 Zeleno hnedá RAL 7013	128,00	153,60	128,00	153,60	145,00	174,00
	032409 *		032423 *		032447 *	
BH 5 Bielo hliníková RAL 9006	128,00	153,60	128,00	153,60	145,00	174,00
	031358 *		031372 *		031396 *	
BHT 6 Bielo hliníková tmavá RAL 9007						
MH 7 Medeno hnedá RAL 8004	128,00	153,60	128,00	153,60	145,00	174,00
	031655 *		031679 *		031693 *	
IC 8 Intenzívna čierna RAL 9005	128,00	153,60	128,00	153,60	145,00	174,00
	031501 *		031525 *		031549 *	
OC 9 Oceľovo červená RAL 3009	128,00	153,60	128,00	153,60	145,00	174,00
	031952 *		031976 *		031990 *	
B 10 Biela RAL 9010	128,00	153,60	128,00	153,60	145,00	174,00
	031204 *		031228 *		031242 *	
MZ 11 Machovo zelená RAL 6005	128,00	153,60	128,00	153,60	145,00	174,00
	031808 *		031822 *		031846 *	
ZS 12 Zinkovo šedá RAL extra	128,00	153,60	128,00	153,60	145,00	174,00
	032553 *		032577 *		032591 *	
PZ 13 Patina zelená RAL extra						
PM 14 Patina meď RAL extra						
Hliník 15 Natur	115,20	138,24	115,20	138,24	130,50	156,60
	030900 *		030924 *		030948 *	
Balenie v ks 	2		2		2	
Balenie v ks 	36		36		36	

* Výroba na objednávku



KOTLÍK ZBERNÝ KUBICKÝ EXZENTRICKÝ

W-WKLZ KX



Menovitá veľkosť	80		100		120	
	Bez DPH	S DPH	Bez DPH	S DPH	Bez DPH	S DPH
AN 1 Antracit RAL 7016	135,00	162,00	135,00	162,00	145,00	174,00
	031112 *		031143		031174 *	
TM 2 Testa di Moro RAL 8028	135,00	162,00	135,00	162,00	145,00	174,00
	032317 *		032348 *		032379 *	
SS 3 Svetlo šedá RAL 7005	135,00	162,00	135,00	162,00	145,00	174,00
	032164 *		032195 *		032225 *	
ZH 4 Zeleno hnedá RAL 7013	135,00	162,00	135,00	162,00	145,00	174,00
	032461 *		032492 *		032522 *	
BH 5 Bielo hliníková RAL 9006	135,00	162,00	135,00	162,00	145,00	174,00
	031419 *		031440 *		031471 *	
BHT 6 Bielo hliníková tmavá RAL 9007	135,00	162,00	135,00	162,00	145,00	174,00
	101662 *		101686 *		101709 *	
MH 7 Medeno hnedá RAL 8004	135,00	162,00	135,00	162,00	145,00	174,00
	031716 *		031747 *		031778 *	
IC 8 Intenzívna čierna RAL 9005	135,00	162,00	135,00	162,00	145,00	174,00
	031563 *		031594 *		031624 *	
OC 9 Oceľovo červená RAL 3009	135,00	162,00	135,00	162,00	145,00	174,00
	032010 *		032041 *		032072 *	
B 10 Biela RAL 9010	135,00	162,00	135,00	162,00	145,00	174,00
	031266 *		031297 *		031327 *	
MZ 11 Machovo zelená RAL 6005	135,00	162,00	135,00	162,00	145,00	174,00
	031860 *		031891 *		031921 *	
ZS 12 Zinkovo šedá RAL extra	135,00	162,00	135,00	162,00	145,00	174,00
	032614 *		032645 *		032676 *	
PZ 13 Patina zelená RAL extra						
PM 14 Patina meď RAL extra						
Hliník 15 Natur	121,50	145,80	121,50	145,80	130,50	156,60
	030962 *		030993 *		031020 *	
Balenie v ks 	2		2		2	
Balenie v ks 	36		36		36	

* Výroba na objednávku



KOTLÍK ZBERNÝ KUBICKÝ EXZENTRICKÝ VÝTOK

W-WKLZ KXV

Menovitá veľkosť	80		100		120	
	Bez DPH	S DPH	Bez DPH	S DPH	Bez DPH	S DPH
AN 1 Antracit RAL 7016	160,00	192,00	160,00	192,00	170,00	204,00
	031129 *		031150 *		031181 *	
TM 2 Testa di Moro RAL 8028	160,00	192,00	160,00	192,00	170,00	204,00
	032324 *		032355 *		032386 *	
SS 3 Svetlo šedá RAL 7005	160,00	192,00	160,00	192,00	170,00	204,00
	032171 *		032201 *		032232 *	
ZH 4 Zeleno hnedá RAL 7013	160,00	192,00	160,00	192,00	170,00	204,00
	032478 *		032508 *		032539 *	
BH 5 Bielo hliníková RAL 9006	160,00	192,00	160,00	192,00	170,00	204,00
	031426 *		031457 *		031488 *	
BHT 6 Bielo hliníková tmavá RAL 9007						
MH 7 Medeno hnedá RAL 8004	160,00	192,00	160,00	192,00	170,00	204,00
	031723 *		031754 *		031785 *	
IC 8 Intenzívna čierna RAL 9005	160,00	192,00	160,00	192,00	170,00	204,00
	031570 *		031600 *		031631 *	
OC 9 Oceľovo červená RAL 3009	160,00	192,00	160,00	192,00	170,00	204,00
	032027 *		032058 *		032089 *	
B 10 Biela RAL 9010	160,00	192,00	160,00	192,00	170,00	204,00
	031273 *		031303 *		031334 *	
MZ 11 Machovo zelená RAL 6005	160,00	192,00	160,00	192,00	170,00	204,00
	031877 *		031907 *		031938 *	
ZS 12 Zinkovo šedá RAL extra	160,00	192,00	160,00	192,00	170,00	204,00
	032621 *		032652 *		032683 *	
PZ 13 Patina zelená RAL extra						
PM 14 Patina meď RAL extra						
Hliník 15 Natur	144,00	172,80	144,00	172,80	153,00	183,60
	030979 *		031006 *		031037 *	
Balenie v ks 	2		2		2	
Balenie v ks 	36		36		36	



* Výroba na objednávku



EPDM TESNIACA GUMA ZBERNÉHO KOTLIČKA

P-PKLZ T



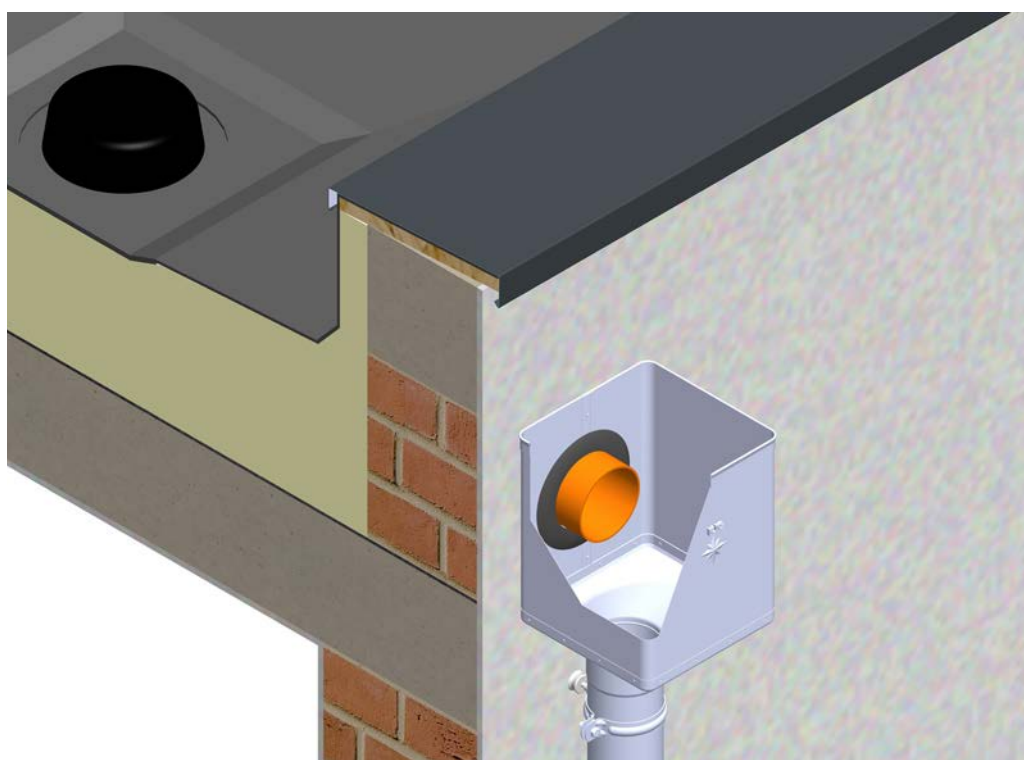

Menovitá veľkosť	EAN číslo výrobku	Balenie v ks		Cena [€/ks]	
				Bez DPH	S DPH
IC 70-85	077103	5	600	4,00	4,80
IC 100-110	077110	5	600	4,10	4,92
IC 110-125	077097	5	600	4,20	5,04
PS 70-85	077134	5	600	4,50	5,40
PS 100-110	077141	5	600	4,90	5,88
PS 110-125	077127	5	600	5,00	6,00



ZVODOVÉ KOLENO 72°

W-WK

Menovitá veľkosť	60		80		100		120		150	
	Bez DPH	S DPH	Bez DPH	S DPH	Bez DPH	S DPH	Bez DPH	S DPH	Bez DPH	S DPH
AN 1 Antracit RAL 7016	9,20	11,04	9,00	10,80	9,60	11,52	14,60	17,52	32,50	39,00
	074294		074300		074324		074348		074362	
TM 2 Testa di Moro RAL 8028	9,20	11,04	9,00	10,80	9,60	11,52	14,60	17,52	32,50	39,00
	074935		074942		074966		074980		075000 *	
SS 3 Svetlo šedá RAL 7005	9,20	11,04	9,00	10,80	9,60	11,52	14,60	17,52	32,50	39,00
	074850 *		074867		074881		074904		074928 *	
ZH 4 Zeleno hnedá RAL 7013	9,20	11,04	9,00	10,80	9,60	11,52	14,60	17,52	32,50	39,00
	075017 *		075024		075048		075062		075086	
BH 5 Bielo hliníková RAL 9006	9,20	11,04	9,00	10,80	9,60	11,52	14,60	17,52	32,50	39,00
	074461		074454		074485		074508		074522 *	
BHT 6 Bielo hliníková tmavá RAL 9007			9,00	10,80	9,60	11,52	14,60	17,52		
			101587		101563		101549 *			
MH 7 Medeno hnedá RAL 8004	9,20	11,04	9,00	10,80	9,60	11,52	14,60	17,52	32,50	39,00
	074614		074621		074645		074669		074683 *	
IC 8 Intenzívna čierna RAL 9005	9,20	11,04	9,00	10,80	9,60	11,52	14,60	17,52	32,50	39,00
	074539 *		074546		074560		074584		074607 *	
OC 9 Oceľovo červená RAL 3009	9,20	11,04	9,00	10,80	9,60	11,52	14,60	17,52	32,50	39,00
	074775 *		074782		074805		074829		074843 *	
B 10 Biela RAL 9010	9,20	11,04	9,00	10,80	9,60	11,52	14,60	17,52	32,50	39,00
	074379		074386		074409		074423		074447 *	
MZ 11 Machovo zelená RAL 6005	9,20	11,04	9,00	10,80	9,60	11,52	14,60	17,52	32,50	39,00
	074690 *		074706		074720		074744		074768 *	
ZS 12 Zinkovo šedá RAL extra	9,20	11,04	9,00	10,80	9,60	11,52	14,60	17,52	32,50	39,00
	075093 *		075109		075123		075147		075161 *	
PZ 13 Patina zelená RAL extra					9,20	11,04				
					112644					
PM 14 Patina meď RAL extra					9,20	11,04				
					112620					
Hliník 15 Natur	8,10	9,72	8,10	9,72	8,90	10,68	14,50	17,40	29,00	34,80
	074218		074225		074249		074263		074287 *	
Balenie v ks 	25		25		25		15		5	
Balenie v ks 	600		400		300		180		60	



* Výroba na objednávku



ZVODOVÉ KOLENO RÁDIUS 85°

W-WKR



Menovitá veľkosť	80		100		120	
	Bez DPH	S DPH	Bez DPH	S DPH	Bez DPH	S DPH
AN 1 Antracit RAL 7016	11,20	13,44	14,00	16,80	18,00	21,60
	074317		074331		074355 *	
TM 2 Testa di Moro RAL 8028	11,20	13,44	14,00	16,80	18,00	21,60
	074959		074973		074997 *	
SS 3 Svetlo šedá RAL 7005	11,20	13,44	14,00	16,80	18,00	21,60
	074874 *		074898		074911 *	
ZH 4 Zeleno hnedá RAL 7013	11,20	13,44	14,00	16,80	18,00	21,60
	075031 *		075055		075079 *	
BH 5 Bielo hliníková RAL 9006	11,20	13,44	14,00	16,80	18,00	21,60
	074478 *		074492		074515 *	
BHT 6 Bielo hliníková tmavá RAL 9007	11,20	13,44	14,00	16,80	18,00	21,60
	101570 *		101556 *		101532 *	
MH 7 Medeno hnedá RAL 8004	11,20	13,44	14,00	16,80	18,00	21,60
	074638 *		074652		074676 *	
IC 8 Intenzívna čierna RAL 9005	11,20	13,44	14,00	16,80	18,00	21,60
	074553 *		074577 *		074591 *	
OC 9 Oceľovo červená RAL 3009	11,20	13,44	14,00	16,80	18,00	21,60
	074799 *		074812 *		074836 *	
B 10 Biela RAL 9010	11,20	13,44	14,00	16,80	18,00	21,60
	074393		074416		074430 *	
MZ 11 Machovo zelená RAL 6005	11,20	13,44	14,00	16,80	18,00	21,60
	074713 *		074737 *		074751 *	
ZS 12 Zinkovo šedá RAL extra	11,20	13,44	14,00	16,80	18,00	21,60
	075116 *		075130 *		075154 *	
PZ 13 Patina zelená RAL extra			9,80	11,76		
			112651			
PM 14 Patina meď RAL extra			9,80	11,76		
			112637			
Hliník 15 Natur	10,10	12,12	12,60	15,12	16,20	19,44
	074232 *		074256		074270 *	
Balenie v ks 	25		25		15	
Balenie v ks 	400		300		180	

* Výroba na objednávku

ZVODOVÉ KOLENO TUPÉ 40°

W-WKT

Menovitá veľkosť	80		100		120	
	Bez DPH	S DPH	Bez DPH	S DPH	Bez DPH	S DPH
AN 1 Antracit RAL 7016	8,90	10,68	11,00	13,20	14,90	17,88
	081414		081421		081438	
TM 2 Testa di Moro RAL 8028	8,90	10,68	11,00	13,20	14,90	17,88
	081650		081667		081674 *	
SS 3 Svetlo šedá RAL 7005	8,90	10,68	11,00	13,20	14,90	17,88
	081629		081636		081643	
ZH 4 Zeleno hnedá RAL 7013	8,90	10,68	11,00	13,20	14,90	17,88
	081681		081698		081704	
BH 5 Bielo hliníková RAL 9006	8,90	10,68	11,00	13,20	14,90	17,88
	081476		081483		081490 *	
BHT 6 Bielo hliníková tmavá RAL 9007	8,90	10,68	11,00	13,20	14,90	17,88
	101778 *		101785 *		101792 *	
MH 7 Medeno hnedá RAL 8004	8,90	10,68	11,00	13,20	14,90	17,88
	081537		081544		081551 *	
IC 8 Intenzívna čierna RAL 9005	8,90	10,68	11,00	13,20	14,90	17,88
	081506 *		081513 *		081520 *	
OC 9 Oceľovo červená RAL 3009	8,90	10,68	11,00	13,20	14,90	17,88
	081599 *		081605		081612 *	
B 10 Biela RAL 9010	8,90	10,68	11,00	13,20	14,90	17,88
	081445		081452		081469	
MZ 11 Machovo zelená RAL 6005	8,90	10,68	11,00	13,20	14,90	17,88
	081568		081575		081582	
ZS 12 Zinkovo šedá RAL extra	8,90	10,68	11,00	13,20	14,90	17,88
	081711		081728		081735	
PZ 13 Patina zelená RAL extra						
PM 14 Patina meď RAL extra						
Hliník 15 Natur	8,00	9,60	9,90	11,88	13,95	16,74
	081384		081391		081407	
Balenie v ks 	25		25		15	
Balenie v ks 	400		300		240	

* Výroba na objednávku



ZVODOVÁ RÚRA [s=0,70]

W-WZR

Menovitá veľkosť	60		80		80		80	
Dĺžka v m	2,0		3,0		4,0		6,0	
Cena v €/m	Bez DPH	S DPH	Bez DPH	S DPH	Bez DPH	S DPH	Bez DPH	S DPH
AN Antracit RAL 7016	7,90	9,48	7,40	8,88	7,40	8,88	7,40	8,88
	050106		050113		050120		050137 *	
TM Testa di Moro RAL 8028	7,90	9,48	7,40	8,88	7,40	8,88	7,40	8,88
	050762		050779		050786		050793 *	
SS Svetlo šedá RAL 7005	7,90	9,48	7,40	8,88	7,40	8,88	7,40	8,88
	050687		050694		050700		052032 *	
ZH Zeleno hnedá RAL 7013	7,90	9,48	7,40	8,88	7,40	8,88	7,40	8,88
	050861		050878		051059		050892 *	
BH Bielo hliníková RAL 9006	7,90	9,48	7,40	8,88	7,40	8,88	7,40	8,88
	050281		050298		050304		098283 *	
BHT Bielo hliníková tmavá RAL 9007			7,40	8,88				
			101952 *					
MH Medeno hnedá RAL 8004	7,90	9,48	7,40	8,88	7,40	8,88		
	050441 *		050458		050465			
IC Intenzívna čierna RAL 9005	7,90	9,48	7,40	8,88	7,40	8,88		
	050366 *		050373		050380			
OC Oceľovo červená RAL 3009	7,90	9,48	7,40	8,88	7,40	8,88		
	050601		050618		050625 *			
B Biela RAL 9010	7,90	9,48	7,40	8,88	7,40	8,88		
	050205		050212		050229			
MZ Machovo zelená RAL 6005	7,90	9,48	7,40	8,88	7,40	8,88		
	050526		050533		050540			
ZS Zinkovo šedá RAL extra	7,90	9,48	7,40	8,88	7,40	8,88		
	050960 *		050977		050984 *			
PZ Patina zelená RAL extra								
PM Patina med RAL extra								
Hliník Natur	6,30	7,56	5,65	6,78	5,65	6,78	5,65	6,78
	050021		050038		050045		052070 *	
Balenie v m 	10		18		24		30	
Balenie v m 	490		216		288		750	

* Výroba na objednávku



ZVODOVÁ RÚRA [s=0,70]

W-WZR

Menovitá veľkosť	100		100		100	
	3,0		4,0		6,0	
Dĺžka v m	3,0		4,0		6,0	
Cena v €/m	Bez DPH	S DPH	Bez DPH	S DPH	Bez DPH	S DPH
	AN 1 Antracit RAL 7016	7,45	8,94	7,45	8,94	7,30
050144		050151		050168 *		
TM 2 Testa di Moro RAL 8028	7,45	8,94	7,45	8,94	7,30	8,76
	050809		050816		050823 *	
SS 3 Svetlo šedá RAL 7005	7,45	8,94	7,45	8,94	7,30	8,76
	050717		050724		052049 *	
ZH 4 Zeleno hnedá RAL 7013	7,45	8,94	7,45	8,94	7,30	8,76
	050908		050915		050922 *	
BH 5 Bielo hliníková RAL 9006	7,45	8,94	7,45	8,94	7,30	8,76
	050311		050328		052056 *	
BHT 6 Bielo hliníková tmavá RAL 9007	7,45	8,94	7,45	8,94		
	101969		101976			
MH 7 Medeno hnedá RAL 8004	7,45	8,94	7,45	8,94		
	050472		050489			
IC 8 Intenzívna čierna RAL 9005	7,45	8,94	7,45	8,94		
	050397		050403			
OC 9 Oceľovo červená RAL 3009	7,45	8,94	7,45	8,94		
	050632		050649			
B 10 Biela RAL 9010	7,45	8,94	7,45	8,94		
	050236		050243			
MZ 11 Machovo zelená RAL 6005	7,45	8,94	7,45	8,94		
	050557		050564			
ZS 12 Zinkovo šedá RAL extra	7,45	8,94	7,45	8,94		
	050991		051004			
PZ 13 Patina zelená RAL extra	9,95	11,94	9,95	11,94		
	112828		112835 *			
PM 14 Patina med RAL extra	9,95	11,94	9,95	11,94		
	112804		112811 *			
Hliník 15 Natur	6,70	8,04	6,70	8,04	6,55	7,86
	050052		050069		052025 *	
Balenie v m 	18		24		30	
Balenie v m 	180		240		480	

* Výroba na objednávku



ZVODOVÁ RÚRA [s=0,70]

W-WZR

Menovitá veľkosť	120		120		120		150	
Dĺžka v m	3,0		4,0		6,0		3,0	
Cena v €/m	Bez DPH	S DPH	Bez DPH	S DPH	Bez DPH	S DPH	Bez DPH	S DPH
AN 1 Antracit RAL 7016	10,00	12,00	10,00	12,00			15,50	18,60
	050175		050182				050199 *	
TM 2 Testa di Moro RAL 8028	10,00	12,00	10,00	12,00	10,00	12,00	15,50	18,60
	050830		050847		052063 *		050854 *	
SS 3 Svetlo šedá RAL 7005	10,00	12,00	10,00	12,00			15,50	18,60
	050731		050748				050755 *	
ZH 4 Zeleno hnedá RAL 7013	10,00	12,00	10,00	12,00			15,50	18,60
	050939		050946				050953 *	
BH 5 Bielo hliníková RAL 9006	10,00	12,00	10,00	12,00			15,50	18,60
	050335		050342				050359 *	
BHT 6 Bielo hliníková tmavá RAL 9007	10,00	12,00						
	101983							
MH 7 Medeno hnedá RAL 8004	10,00	12,00	10,00	12,00			15,50	18,60
	050496		050502				050519 *	
IC 8 Intenzívna čierna RAL 9005	10,00	12,00	10,00	12,00			15,50	18,60
	050410		050427				050434 *	
OC 9 Oceľovo červená RAL 3009	10,00	12,00	10,00	12,00			15,50	18,60
	050656		050663				050670 *	
B 10 Biela RAL 9010	10,00	12,00	10,00	12,00			15,50	18,60
	050250		050267				050274 *	
MZ 11 Machovo zelená RAL 6005	10,00	12,00	10,00	12,00			15,50	18,60
	050571		050588				050595 *	
ZS 12 Zinkovo šedá RAL extra	10,00	12,00	10,00	12,00			15,50	18,60
	051011 *		051028				051035 *	
PZ 13 Patina zelená RAL extra								
PM 14 Patina med RAL extra								
Hliník 15 Natur	8,30	9,96	8,30	9,96			13,00	15,60
	050076		050083				050090 *	
Balenie v m 	18		24		30		3	
Balenie v m 	144		192		-		84	

* Výroba na objednávku





ALUMINIUM

POLYESTER + NATUR



PLASTOVÝ ZVODOVÝ RUKÁV

SD-ZR FOLIA KJG

Menovitá veľkosť	Dĺžka v m	EAN číslo výrobku	Balenie v m		Cena [€/m]	
					Bez DPH	S DPH
60 – 150	100,0	139726	100	6 000	0,38	0,46

ZVODOVÉ KOLENO ODSKOKOVÉ

W-WKO





Menovitá veľkosť	80		100		120	
	Bez DPH	S DPH	Bez DPH	S DPH	Bez DPH	S DPH
AN 1 Antracit RAL 7016	11,00	13,20	13,50	16,20	16,00	19,20
	063328		008411		011985	
TM 2 Testa di Moro RAL 8028	11,00	13,20	13,50	16,20	16,00	19,20
	023353		023377		023421	
SS 3 Svetlo šedá RAL 7005	11,00	13,20	13,50	16,20	16,00	19,20
	023230		023285		023919	
ZH 4 Zeleno hnedá RAL 7013	11,00	13,20	13,50	16,20	16,00	19,20
	023476		023513		023537	
BH 5 Bielo hliníková RAL 9006	11,00	13,20	13,50	16,20	16,00	19,20
	064837		057877		057884	
BHT 6 Bielo hliníková tmavá RAL 9007	11,00	13,20	13,50	16,20	16,00	19,20
	101716		101723		101730 *	
MH 7 Medeno hnedá RAL 8004	11,00	13,20	13,50	16,20	16,00	19,20
	000316		000330		048738	
IC 8 Intenzívna čierna RAL 9005	11,00	13,20	13,50	16,20	16,00	19,20
	057891		057907		048226 *	
OC 9 Oceľovo červená RAL 3009	11,00	13,20	13,50	16,20	16,00	19,20
	000507		068712		023209	
B 10 Biela RAL 9010	11,00	13,20	13,50	16,20	16,00	19,20
	012029		013804		013811	
MZ 11 Machovo zelená RAL 6005	11,00	13,20	13,50	16,20	16,00	19,20
	011923		000453		000477	
ZS 12 Zinkovo šedá RAL extra	11,00	13,20	13,50	16,20	16,00	19,20
	023582		023629		023650	
PZ 13 Patina zelená RAL extra			16,90	20,28		
			112699			
PM 14 Patina med RAL extra			16,90	20,28		
			112682			
Hliník 15 Natur	9,90	11,88	12,15	14,58	14,40	17,28
	077165		077172		077189	
Balenie v ks 	20		20		15	
Balenie v ks 	320		240		180	

* Výroba na objednávku

ZVODOVÁ ODBOČKA 72°

W-WZO



Menovitá veľkosť	80/80		100/80		100/100	
	Bez DPH	S DPH	Bez DPH	S DPH	Bez DPH	S DPH
AN 1 Antracit RAL 7016	38,50	46,20	39,50	47,40	39,90	47,88
	096630 *		096647 *		096654	
TM 2 Testa di Moro RAL 8028	38,50	46,20	39,50	47,40	39,90	47,88
	110473 *		110480 *		110497	
SS 3 Svetlo šedá RAL 7005	38,50	46,20	39,50	47,40	39,90	47,88
	110404 *		110411 *		110428 *	
ZH 4 Zeleno hnedá RAL 7013	38,50	46,20	39,50	47,40	39,90	47,88
	110541 *		110558 *		110565	
BH 5 Bielo hliníková RAL 9006	38,50	46,20	39,50	47,40	39,90	47,88
	110053 *		110060 *		110077 *	
BHT 6 Bielo hliníková tmavá RAL 9007	38,50	46,20	39,50	47,40	39,90	47,88
	096555 *		096623 *		109972 *	
MH 7 Medeno hnedá RAL 8004	38,50	46,20	39,50	47,40	39,90	47,88
	110190 *		110206 *		110213 *	
IC 8 Intenzívna čierna RAL 9005	38,50	46,20	39,50	47,40	39,90	47,88
	110121 *		110138 *		110145 *	
OC 9 Oceľovo červená RAL 3009	38,50	46,20	39,50	47,40	39,90	47,88
	110336 *		110343 *		110350 *	
B 10 Biela RAL 9010	38,50	46,20	39,50	47,40	39,90	47,88
	109989 *		109996 *		110008 *	
MZ 11 Machovo zelená RAL 6005	38,50	46,20	39,50	47,40	39,90	47,88
	110268 *		110275 *		110282	
ZS 12 Zinkovo šedá RAL extra	38,50	46,20	39,50	47,40	39,90	47,88
	110619 *		110626 *		110633 *	
PZ 13 Patina zelená RAL extra						
PM 14 Patina meď RAL extra						
Hliník 15 Natur	34,60	41,52	35,50	42,60	35,90	43,08
	096562 *		096579		096586	
Balenie v ks 		4		3		4
Balenie v ks 		90		90		120

* Výroba na objednávku

ZVODOVÁ ODBOČKA 72°

W-WZO



Menovitá veľkosť	120/80		120/100		120/120	
	Bez DPH	S DPH	Bez DPH	S DPH	Bez DPH	S DPH
AN 1 Antracit RAL 7016	43,00	51,60	43,60	52,32	43,90	52,68
	096661 *		096678 *		096685 *	
TM 2 Testa di Moro RAL 8028	43,00	51,60	43,60	52,32	43,90	52,68
	110503 *		110510 *		110527 *	
SS 3 Svetlo šedá RAL 7005	43,00	51,60	43,60	52,32	43,90	52,68
	110435 *		110442 *		110459 *	
ZH 4 Zeleno hnedá RAL 7013	43,00	51,60	43,60	52,32	43,90	52,68
	110572 *		110589 *		110596 *	
BH 5 Bielo hliníková RAL 9006	43,00	51,60	43,60	52,32	43,90	52,68
	110084 *		110091 *		110107 *	
BHT 6 Bielo hliníková tmavá RAL 9007	43,00	51,60	43,60	52,32	43,90	52,68
	110046 *		110114 *		110183 *	
MH 7 Medeno hnedá RAL 8004	43,00	51,60	43,60	52,32	43,90	52,68
	110220 *		110237 *		110244 *	
IC 8 Intenzívna čierna RAL 9005	43,00	51,60	43,60	52,32	43,90	52,68
	110152 *		110169 *		110176 *	
OC 9 Oceľovo červená RAL 3009	43,00	51,60	43,60	52,32	43,90	52,68
	110367 *		110374 *		110381 *	
B 10 Biela RAL 9010	43,00	51,60	43,60	52,32	43,90	52,68
	110015 *		110022 *		110039 *	
MZ 11 Machovo zelená RAL 6005	43,00	51,60	43,60	52,32	43,90	52,68
	110299 *		110305 *		110312 *	
ZS 12 Zinkovo šedá RAL extra	43,00	51,60	43,60	52,32	43,90	52,68
	110640 *		110657 *		110664 *	
PZ 13 Patina zelená RAL extra						
PM 14 Patina meď RAL extra						
Hliník 15 Natur	38,70	46,44	39,30	47,16	39,50	47,40
	096593 *		096609 *		096616 *	
Balenie v ks 	3		3		3	
Balenie v ks 	90		90		90	

* Výroba na objednávku

ZVODOVÁ OBJÍMKA M10

W-WOB

Menovitá veľkosť	60		80		100		120		150	
	Bez DPH	S DPH	Bez DPH	S DPH	Bez DPH	S DPH	Bez DPH	S DPH	Bez DPH	S DPH
AN 1 Antracit RAL 7016	3,55	4,26	3,35	4,02	3,40	4,08	3,90	4,68	5,85	7,02
	054982		054999		055002		055019		055026	
TM 2 Testa di Moro RAL 8028	3,55	4,26	3,35	4,02	3,40	4,08	3,90	4,68	5,85	7,02
	055439		055446		055453		055460		055477 *	
SS 3 Svetlo šedá RAL 7005	3,55	4,26	3,35	4,02	3,40	4,08	3,90	4,68	5,85	7,02
	055330 *		055347		055354		055361		055378 *	
ZH 4 Zeleno hnedá RAL 7013	3,55	4,26	3,35	4,02	3,40	4,08	3,90	4,68	5,85	7,02
	055514		055521		055538		055545		055552 *	
BH 5 Bielo hliníková RAL 9006	3,55	4,26	3,35	4,02	3,40	4,08	3,90	4,68	5,85	7,02
	055088		055095		055101		055118		055125 *	
BHT 6 Bielo hliníková tmavá RAL 9007			3,35	4,02	3,40	4,08	3,90	4,68		
			101808		101815		101822 *			
MH 7 Medeno hnedá RAL 8004	3,55	4,26	3,35	4,02	3,40	4,08	3,90	4,68	5,85	7,02
	055187 *		055194		055200		055217		055224 *	
IC 8 Intenzívna čierna RAL 9005	3,55	4,26	3,35	4,02	3,40	4,08	3,90	4,68	5,85	7,02
	055132 *		055149		055156		055163		055170 *	
OC 9 Oceľovo červená RAL 3009	3,55	4,26	3,35	4,02	3,40	4,08	3,90	4,68	5,85	7,02
	055286 *		055293		055309		055316		055323 *	
B 10 Biela RAL 9010	3,55	4,26	3,35	4,02	3,40	4,08	3,90	4,68	5,85	7,02
	055033		055040		055057		055064		055071 *	
MZ 11 Machovo zelená RAL 6005	3,55	4,26	3,35	4,02	3,40	4,08	3,90	4,68	5,85	7,02
	055231 *		055248		055255		055262		055279 *	
ZS 12 Zinkovo šedá RAL extra	3,55	4,26	3,35	4,02	3,40	4,08	3,90	4,68	5,85	7,02
	055569 *		055576		055583		055590		055606 *	
PZ 13 Patina zelená RAL extra					8,30	9,96				
					112712					
PM 14 Patina meď RAL extra					8,30	9,96				
					112705					
Hliník 15 Natur	2,80	3,36	2,60	3,12	2,70	3,24	3,00	3,60	4,65	5,58
	054906 *		054913		054920		054937		054944 *	
Balenie v ks	25		25		25		25		20	
Balenie v ks	3 000		3 000		3 000		3 000		2 400	



* Výroba na objednávku



NEREZOVÁ SKRUTKA S PVC PODLOŽKOU M8x30

P-POB-NSK





Menovitá veľkosť	EAN číslo výrobku	Balenie v ks		Cena [€/ks]	
				Bez DPH	S DPH
M8 x 30 *	139658	1	–	0,25	0,30

* Výroba na objednávku

ZÁVITOVÝ HROT TORX M10

P-POB-HT





Menovitá veľkosť	EAN číslo výrobku	Balenie v ks		Cena [€/ks]	
				Bez DPH	S DPH
80	002464	100	40 000	1,00	1,20
140	002471	100	28 000	1,25	1,50
200	002488	100	20 000	1,55	1,86
250	002495	100	16 000	1,70	2,04
300	002501	100	11 200	1,70	2,04

ALUMINIUM
POLYESTER + NATUR

HMOŽDINKA MODRÁ BEZ LAMELY M10

P-POB-HN DB





Menovitá veľkosť	EAN číslo výrobku	Balenie v ks		Cena [€/ks]	
				Bez DPH	S DPH
120	002426	100	25 000	0,40	0,48

HMOŽDINKA MODRÁ S LAMELOU M10

P-POB-HN DB





Menovitá veľkosť	EAN číslo výrobku	Balenie v ks		Cena [€/ks]	
				Bez DPH	S DPH
180	002433	100	12 000	0,42	0,50
240	002440	100	12 000	0,50	0,60
280	002457	100	12 000	0,53	0,64

KOMBISKRUTKA TORX M10

P-POB-ZT/SZ



Menovitá veľkosť	EAN číslo výrobku	Balenie v ks		Cena [€/ks]	
				Bez DPH	S DPH
140	002587	50	10 400	0,45	0,54
180	002594	50	10 400	0,55	0,66



ALUMINIUM

POLYESTER + NATUR

NYLON IZOLAČNÁ HMOŽDINKA S OCHRANNOU KRYTKOU M10

P-POB-HN IZOL





Menovitá veľkosť	EAN číslo výrobku	Balenie v ks		Cena [€/ks]	
				Bez DPH	S DPH
M10 x 96	001207	25	2 625	2,95	3,54

ZÁVITOVÁ TYČ M10

P-POB-ZT





Menovitá veľkosť	EAN číslo výrobku	Balenie v ks		Cena [€/ks]	
				Bez DPH	S DPH
60	002556	100	20 800	0,20	0,24
100	002563	100	15 600	0,30	0,36
150	002570	50	10 400	0,55	0,66

MONTÁŽNA PLATŇA M10

P-POB-ZT MP













Menovitá veľkosť	EAN číslo výrobku	Balenie v ks		Cena [€/ks]	
				Bez DPH	S DPH
80 x 30	002518	25	5 200	1,15	1,38

GUMOVÁ FAREBNÁ KRYTKA HROTU OBJÍMKY

P-POB-HT AKG





Menovitá veľkosť	EAN číslo výrobku	Balenie v ks		Cena [€/ks]	
				Bez DPH	S DPH
 29 x 13	002280	50	16 800	0,25	0,30
 29 x 13	002211	50	16 800	0,25	0,30
 29 x 13	002235	50	16 800	0,25	0,30
 29 x 13	002266	50	16 800	0,25	0,30
 29 x 13	002242	50	16 800	0,25	0,30
 29 x 13	002228	50	16 800	0,25	0,30
 29 x 13	002273	50	16 800	0,25	0,30
 29 x 13	002259	50	16 800	0,25	0,30
 29 x 13	002297	50	16 800	0,25	0,30

ZACHYTÁVAČ VODY



W-WZV



Menovitá veľkosť	80		100		120	
Cena v €/ks	Bez DPH		Bez DPH		Bez DPH	
AN 1 Antracit RAL 7016	21,00	25,20	22,00	26,40	30,00	36,00
	035073		035080		035097	
TM 2 Testa di Moro RAL 8028	21,00	25,20	22,00	26,40	30,00	36,00
	035103		035110		035127	
ZH 4 Zeleno hnedá RAL 7013	21,00	25,20	22,00	26,40	30,00	36,00
	035134		035141		035158	
Balenie v ks 	6		5		3	
Balenie v ks 	180		150		90	

ZACHYTÁVAČ VODY+SITKO

W-WZVS



Menovitá veľkosť	80		100		120	
	Bez DPH	S DPH	Bez DPH	S DPH	Bez DPH	S DPH
AN 1 Antracit RAL 7016	25,50	30,60	28,00	33,60	42,00	50,40
	035226		035233		035240	
TM 2 Testa di Moro RAL 8028	25,50	30,60	28,00	33,60	42,00	50,40
	035462		035479		035486	
SS 3 Svetlo šedá RAL 7005	25,50	30,60	28,00	33,60	42,00	50,40
	035431		035448		035455	
ZH 4 Zeleno hnedá RAL 7013	25,50	30,60	28,00	33,60	42,00	50,40
	035493		035509		035516	
BH 5 Bielo hliníková RAL 9006	25,50	30,60	28,00	33,60	42,00	50,40
	035288		035295		035301	
BHT 6 Bielo hliníková tmavá RAL 9007	25,50	30,60	28,00	33,60	42,00	50,40
	102034 *		102041 *		102058 *	
MH 7 Medeno hnedá RAL 8004	25,50	30,60	28,00	33,60	42,00	50,40
	035349		035356		035363	
IC 8 Intenzívna čierna RAL 9005	25,50	30,60	28,00	33,60	42,00	50,40
	035318		035325		035332 *	
OC 9 Oceľovo červená RAL 3009	25,50	30,60	28,00	33,60	42,00	50,40
	035400		035417		035424	
B 10 Biela RAL 9010	25,50	30,60	28,00	33,60	42,00	50,40
	035257		035264		035271	
MZ 11 Machovo zelená RAL 6005	25,50	30,60	28,00	33,60	42,00	50,40
	035370		035387		035394	
ZS 12 Zinkovo šedá RAL extra	25,50	30,60	28,00	33,60	42,00	50,40
	035523		035530		035547	
PZ 13 Patina zelená RAL extra						
PM 14 Patina meď RAL extra						
Hliník 15 Natur	20,40	24,48	22,40	26,88	33,60	40,32
	035196 *		035202		035219 *	
Balenie v ks 	6		5		3	
Balenie v ks 	180		150		90	

* Výroba na objednávku



ZACHYTÁVAČ VODY+HADICA

W-WZVHA

Menovitá veľkosť	80		100		120	
	Bez DPH	S DPH	Bez DPH	S DPH	Bez DPH	S DPH
AN 1 Antracit RAL 7016	65,00	78,00	65,00	78,00	125,00	150,00
	018854		018861		018878 *	
TM 2 Testa di Moro RAL 8028	65,00	78,00	65,00	78,00	125,00	150,00
	019097		019103		019110	
SS 3 Svetlo šedá RAL 7005	65,00	78,00	65,00	78,00	125,00	150,00
	019066 *		019073		019080 *	
ZH 4 Zeleno hnedá RAL 7013	65,00	78,00	65,00	78,00	125,00	150,00
	019127 *		019134		019141 *	
BH 5 Bielo hliníková RAL 9006	65,00	78,00	65,00	78,00	125,00	150,00
	018915 *		018922		018939 *	
BHT 6 Bielo hliníková tmavá RAL 9007	65,00	78,00	65,00	78,00	125,00	150,00
	102003 *		102010 *		102027 *	
MH 7 Medeno hnedá RAL 8004	65,00	78,00	65,00	78,00	125,00	150,00
	018977 *		018984 *		018991 *	
IC 8 Intenzívna čierna RAL 9005	65,00	78,00	65,00	78,00	125,00	150,00
	018946 *		018953		018960	
OC 9 Oceľovo červená RAL 3009	65,00	78,00	65,00	78,00	125,00	150,00
	019035 *		019042 *		019059 *	
B 10 Biela RAL 9010	65,00	78,00	65,00	78,00	125,00	150,00
	018885 *		018892		018908 *	
MZ 11 Machovo zelená RAL 6005	65,00	78,00	65,00	78,00	125,00	150,00
	019004		019011		019028 *	
ZS 12 Zinkovo šedá RAL extra	65,00	78,00	65,00	78,00	125,00	150,00
	019158 *		019165 *		019172 *	
PZ 13 Patina zelená RAL extra						
PM 14 Patina meď RAL extra						
Hliník 15 Natur	58,50	70,20	58,50	70,20	112,50	135,00
	001481		001498		001504	
Balenie v ks 	1		1		1	
Balenie v ks 	60		60		60	

* Výroba na objednávku



POZINKOVANÁ OCHRANNÁ RÚRA S REVÍZNYM OTVOROM W-WOZR

Menovitá veľkosť	80		100		100	
	Bez DPH	S DPH	Bez DPH	S DPH	Bez DPH	S DPH
Dĺžka v m	1,0		1,0		1,5	
Cena v €/ks	Bez DPH	S DPH	Bez DPH	S DPH	Bez DPH	S DPH
AN 1 Antracit RAL 7016	64,00	76,80	49,00	58,80	97,00	116,40
	030344 *		030351 *		030368 *	
TM 2 Testa di Moro RAL 8028	64,00	76,80	49,00	58,80	97,00	116,40
	030641 *		030658 *		030665 *	
SS 3 Svetlo šedá RAL 7005	64,00	76,80	49,00	58,80	97,00	116,40
	030597 *		030603 *		030610 *	
ZH 4 Zeleno hnedá RAL 7013	64,00	76,80	49,00	58,80	97,00	116,40
	030696 *		030702 *		030719 *	
BH 5 Bielo hliníková RAL 9006	64,00	76,80	49,00	58,80	97,00	116,40
	030795 *		030801 *		030818 *	
BHT 6 Bielo hliníková tmavá RAL 9007	64,00	76,80	49,00	58,80	97,00	116,40
	102065 *		102072 *		102096 *	
MH 7 Medeno hnedá RAL 8004	64,00	76,80	49,00	58,80	97,00	116,40
	030443 *		030450 *		030467 *	
IC 8 Intenzívna čierna RAL 9005	64,00	76,80	49,00	58,80	97,00	116,40
	030849 *		030856 *		030863 *	
OC 9 Oceľovo červená RAL 3009	64,00	76,80	49,00	58,80	97,00	116,40
	030542 *		030559 *		030566 *	
B 10 Biela RAL 9010	64,00	76,80	49,00	58,80	97,00	116,40
	030399 *		030405 *		030412 *	
MZ 11 Machovo zelená RAL 6005	64,00	76,80	49,00	58,80	97,00	116,40
	030498 *		030504 *		030511 *	
ZS 12 Zinkovo šedá RAL extra	64,00	76,80	49,00	58,80	97,00	116,40
	030740 *		030757 *		030764 *	
PZ 13 Patina zelená RAL extra						
PM 14 Patina med RAL extra						
Pozink Natur	60,00	72,00	45,00	54,00	89,00	106,80
	009708		009715		009722	
Balenie v ks 	1		1		1	
Balenie v ks 	70		60		60	

* Výroba na objednávku



POZINKOVANÁ OCHRANNÁ RÚRA S REVÍZNYM OTVOROM W-WOZR

Menovitá veľkosť	120		120	
	Dĺžka v m			
Cena v €/ks	1,0		1,5	
	Bez DPH	S DPH	Bez DPH	S DPH
AN Antracit RAL 7016	115,00	138,00	165,00	198,00
	030375 *		030382 *	
TM Testa di Moro RAL 8028	115,00	138,00	165,00	198,00
	030672 *		030689 *	
SS Svetlo šedá RAL 7005	115,00	138,00	165,00	198,00
	030627 *		030634 *	
ZH Zeleno hnedá RAL 7013	115,00	138,00	165,00	198,00
	030726 *		030733 *	
BH Bielo hliníková RAL 9006	115,00	138,00	165,00	198,00
	030825 *		030832 *	
BHT Bielo hliníková tmavá RAL 9007	115,00	138,00	165,00	198,00
	102102 *		102089 *	
MH Medeno hnedá RAL 8004	115,00	138,00	165,00	198,00
	030474 *		030481 *	
IC Intenzívna čierna RAL 9005	115,00	138,00	165,00	198,00
	030870 *		030887 *	
OC Oceľovo červená RAL 3009	115,00	138,00	165,00	198,00
	030573 *		030580 *	
B Biela RAL 9010	115,00	138,00	165,00	198,00
	030429 *		030436 *	
MZ Machovo zelená RAL 6005	115,00	138,00	165,00	198,00
	030528 *		030535 *	
ZS Zinkovo šedá RAL extra	115,00	138,00	165,00	198,00
	030771 *		030788 *	
PZ Patina zelená RAL extra				
PM Patina med RAL extra				
Pozink Natur	105,00	126,00	143,00	171,60
	009739		009746	
Balenie v ks 	1		1	
Balenie v ks 	40		40	

* Výroba na objednávku





ALUMINIUM

POLYESTER + NATUR

POZINKOVANÁ OBJÍMKA S REBROVOU GUMOU M10

P-POB-OZR



Menovitá velikost'	EAN číslo výrobku	Balenie v ks		Cena [€/ks]	
				Bez DPH	S DPH
80	002525	25	1 250	1,55	1,86
100	002532	25	1 250	2,00	2,40
120	002549	20	1 000	2,25	2,70

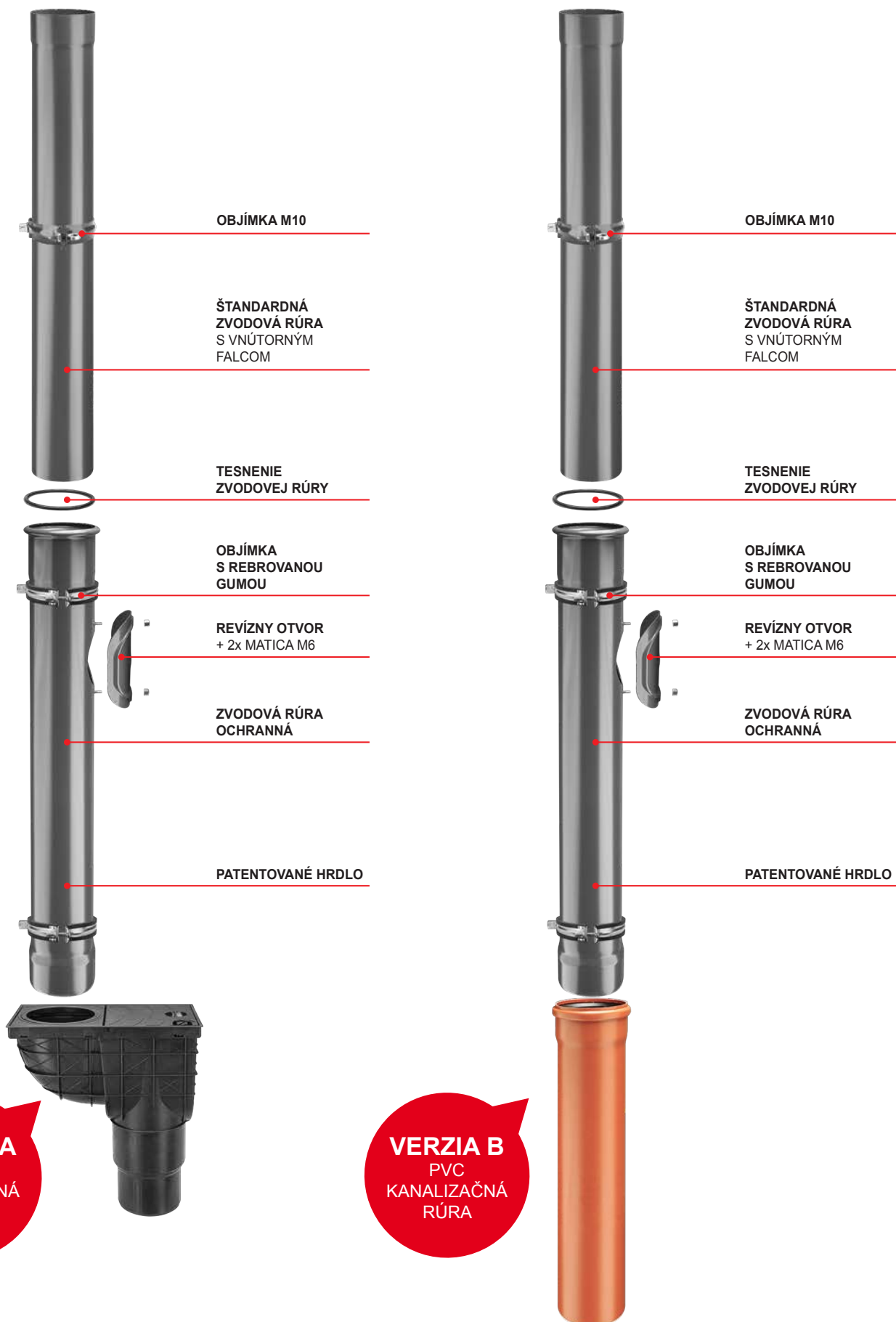

ALUMINIUM
POLYESTER + NATUR

