



ODKVAPOVÝ SYSTÉM POLKRUHOVÝ



**CENNÍK
2023**



POWERFUL PARTNER FOR YOUR ROOF



Pozinkovaný
materiál | 3



Žraby | 6



Dilatácie | 12



Žraby
príslušenstvo | 15



Háky | 19



Rohy | 24



Čelá | 26



Kotlíky | 28



Kolená | 40



Zvodové
rúry | 45



Zvodové rúry
príslušenstvo | 52



Objímky | 55



Objímky
príslušenstvo | 59



Zachytávače
vody | 62



Ochranné
zvodové rúry | 65

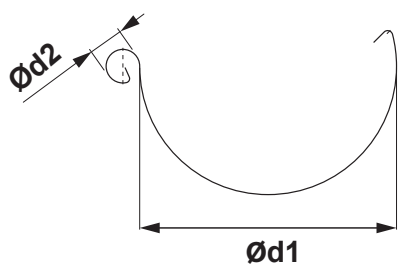

ROZMERY STREŠNÝCH ŽLABOV

(rozmery a rozmerové tolerancie podľa EN 612)

Rozvinutá šírka (mm)	200	250	280	333	400	500
Ød1	80	105	127	153	192	250
Ød2	16	18	18	20	22	22

VNÚTORNÝ FALZ

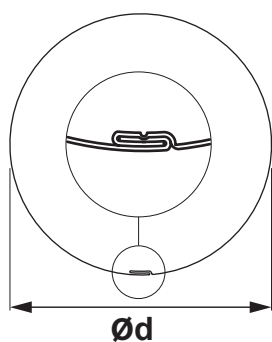

ROZMERY STREŠNÝCH ZVODOV

(rozmery a rozmerové tolerancie podľa EN 612)

Rozmery	60	80	100	120	150
Menovitá veľkosť Ød (mm)	60	80	100	120	150

ROZMERY STREŠNÝCH HÁKOV

(rozmery a rozmerové tolerancie podľa EN 612)

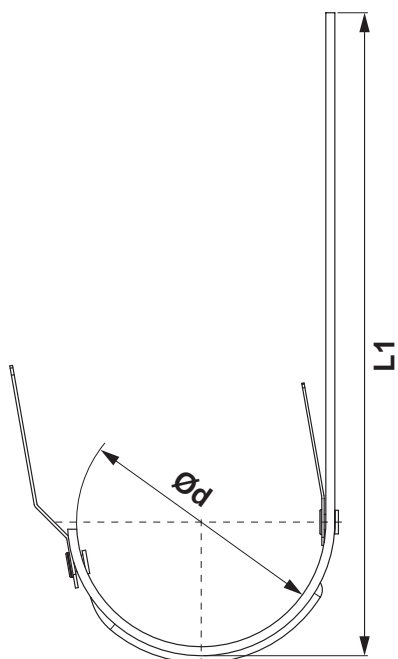

Rozmery (mm)	L1	Ød
200	290	80
250	310	105
280	345	127
333 – 510	345	153
333 – 550	385	153
333 – 610	445	153
400	400	192

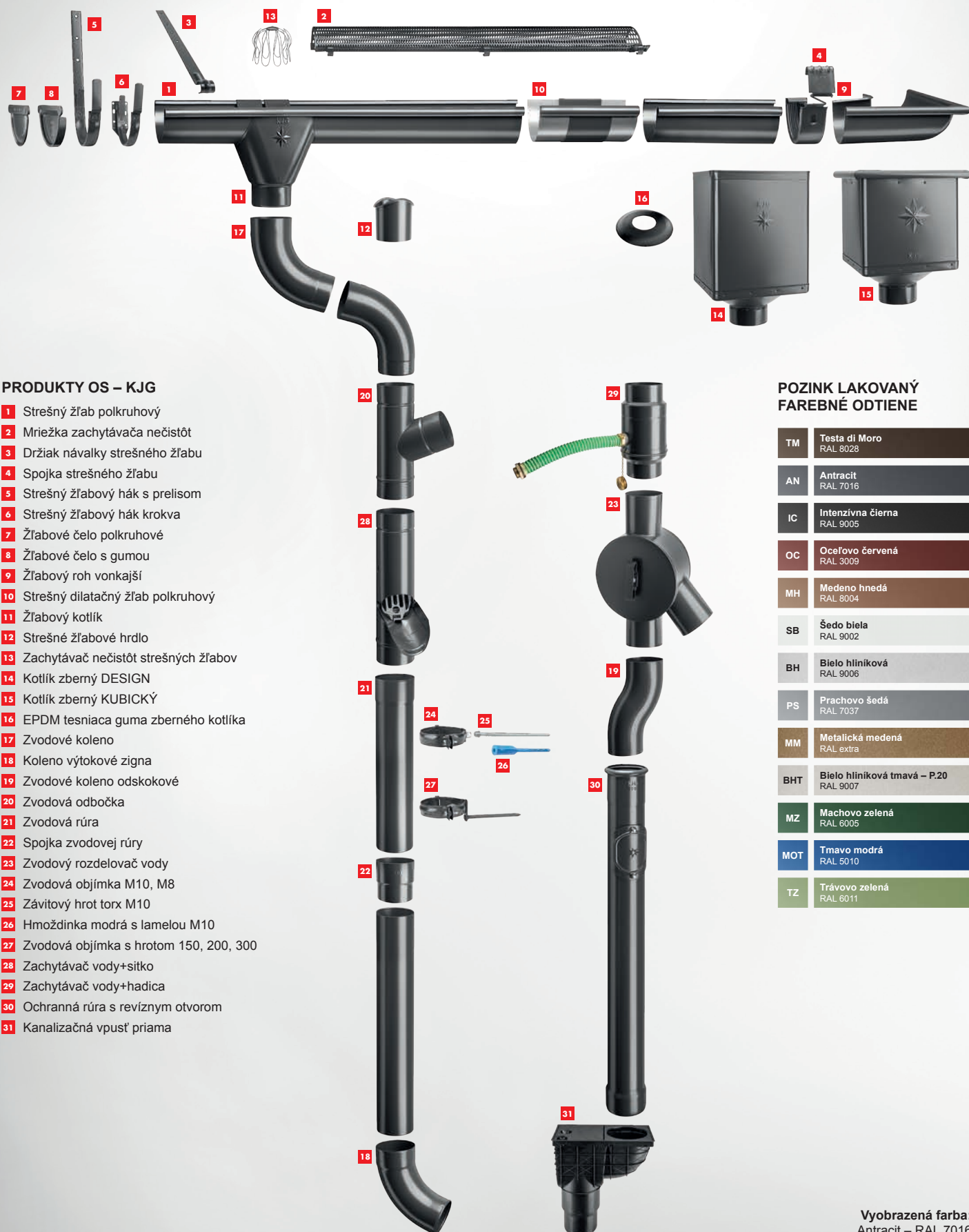

PRODUKTY OS – KJG

- 1 Strešný žlab polkruhový
- 2 Mriežka zachytávača nečistôt
- 3 Držiak návalky strešného žlabu
- 4 Spojka strešného žlabu
- 5 Strešný žlabový hák s prelisom
- 6 Strešný žlabový hák krokva
- 7 Žlabové čelo polkruhové
- 8 Žlabové čelo s gumou
- 9 Žlabový roh vonkajší
- 10 Strešný dilatačný žlab polkruhový
- 11 Žlabový kotlík
- 12 Strešné žlabové hrdlo
- 13 Zachytávač nečistôt strešných žlabov
- 14 Kotlík zberný DESIGN
- 15 Kotlík zberný KUBICKÝ
- 16 EPDM tesniaca guma zberného kotlíka
- 17 Zvodové koleno
- 18 Koleno výtokové zigna
- 19 Zvodové koleno odskokové
- 20 Zvodová odbočka
- 21 Zvodová rúra
- 22 Spojka zvodovej rúry
- 23 Zvodový rozdelovač vody
- 24 Zvodová objímka M10, M8
- 25 Závitový hrot torx M10
- 26 Hmoždinka modrá s lamelou M10
- 27 Zvodová objímka s hrotom 150, 200, 300
- 28 Zachytávač vody+sitko
- 29 Zachytávač vody+hadica
- 30 Ochranná rúra s revíznym otvorom
- 31 Kanalizačná vpusť priama

POZINK LAKOVANÝ FAREBNÉ ODTIENE

TM	Testa di Moro RAL 8028
AN	Antracit RAL 7016
IC	Intenzívna čierna RAL 9005
OC	Oceľovo červená RAL 3009
MH	Medeno hnedá RAL 8004
SB	Šedo biela RAL 9002
BH	Bielo hliníková RAL 9006
PS	Prachovo šedá RAL 7037
MM	Metalická medená RAL extra
BHT	Bielo hliníková tmavá – P.20 RAL 9007
MZ	Machovo zelená RAL 6005
MOT	Tmavo modrá RAL 5010
TZ	Trávovo zelená RAL 6011

TATA STEEL





Spoločnosť Tata bola založená v roku 1868 spoločnosťou Jamsetji Nusserwanji Tata a sídlom v Indii. Je globálnym obchodným konglomerátom, ktorý pôsobí vo viac ako 100 krajinách na piatich kontinentoch. Od skorého nástupu do ocele a automobilov, aby sa držal krok s najnovšími technológiami, má dnes skupina Tata silnú pozíciu v rôznych odvetviach, ako sú agrochemikálie, automobilový priemysel, chemikálie, stavebníctvo, financie a spotrebné výrobky.

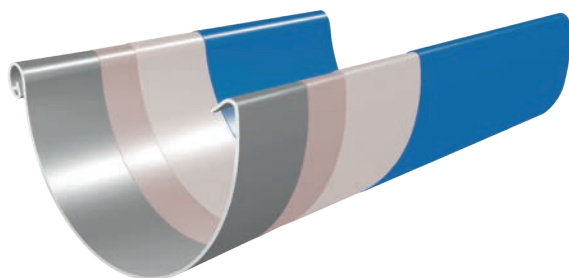

MARCEGAGLIA

Marcegaglia je vedúci hráč v Taliansku a najväčší nezávislý globálny operátor v oceliarskom priemysle. S každým rokom spracovaným 5,6 milióna ton a s obratom viac ako 5 miliárd eur (2017), je Marcegaglia talianskou priemyselnou skupinou, ktorá je popredným hráčom v Európe a na celom svete v transformácii ocele. Získané vedenie je výsledkom dlhej, pevnej a stabilnej rastovej cesty, ktorá robí Marcegaglia najväčším nezávislým globálnym hráčom v transformácii ocele.



-  Vrchná lakovaná vrstva (cca 20 μm) na polyesterovej báze pre výbornú optiku a najvyššiu odolnosť voči poškodeniu
-  Primer (cca 5 μm) pre perfektnú príľnavosť a pevnú antikoróznú ochranu
-  Zinková vrstva (225 g/m²) pre trvalú antikoróznú ochranu
-  Optimalizovaný oceľový pás pre odkvapový systém OS – KJG

STREŠNÝ ŽĽAB POLKRUHOVÝ [s=0,55]

P-PZ

Menovitá veľkosť	200		200		200	
	2,0		3,0		4,0	
Dĺžka v m						
Cena v €/m	Bez DPH	S DPH	Bez DPH	S DPH	Bez DPH	S DPH
TM 1 Testa di Moro RAL 8028	6,95	8,34	6,95	8,34	6,95	8,34
	043610		043627		043634	
AN 2 Antracit RAL 7016	6,95	8,34	6,95	8,34	6,95	8,34
	042187		042194		042200	
IC 3 Intenzívna čierna RAL 9005	6,95	8,34	6,95	8,34	6,95	8,34
	042545		042552		042569	
OC 4 Oceľovo červená RAL 3009			6,95	8,34	6,95	8,34
			043191		043207	
MH 5 Medeno hnedá RAL 8004			7,05	8,46		
			042750			
SB 6 Šedo biela RAL 9002			7,05	8,46		
			043498			
BH 7 Bielo hliníková RAL 9006			7,05	8,46	7,05	8,46
			042392		042408	
PS 8 Prachovo šedá RAL 7037			7,05	8,46	7,05	8,46
			043375		043382	
MM 9 Metalická medená RAL extra			7,50	9,00		
			042927			
BHT – P.20 10 Bielo hliníková tmavá RAL 9007						
MZ 11 Machovo zelená RAL 6005			7,50	9,00		
			043085			
MOT 12 Tmavo modrá RAL 5010			7,50	9,00		
			043016 *			
TZ 13 Trávovo zelená RAL 6011			7,50	9,00		
			043825 *			
Balenie v m 📦			15			
Balenie v m 🚚	800		1 200		1 600	

* Výroba na objednávku

POZINK
POLYESTER



STREŠNÝ ŽLAB POLKRUHOVÝ [s=0,55]

P-PZ

Menovitá veľkosť	250		250		250		250		250	
	2,0		3,0		4,0		5,0		6,0	
Dĺžka v m	2,0		3,0		4,0		5,0		6,0	
Cena v €/m	Bez DPH	S DPH	Bez DPH	S DPH	Bez DPH	S DPH	Bez DPH	S DPH	Bez DPH	S DPH
TM 1 Testa di Moro RAL 8028	6,20	7,44	6,05	7,26	6,05	7,26	6,05	7,26	6,05	7,26
	043641		043658		043665		043672		043689	
AN 2 Antracit RAL 7016	6,20	7,44	6,05	7,26	6,05	7,26	6,05	7,26	6,05	7,26
	042217		042224		042231		042248		042255	
IC 3 Intenzívna čierna RAL 9005	6,20	7,44	6,05	7,26	6,05	7,26	6,05	7,26	6,05	7,26
	042576		042583		042590		042606		042613	
OC 4 Oceľovo červená RAL 3009	6,20	7,44	6,05	7,26	6,05	7,26	6,05	7,26	6,05	7,26
	043214		043221		043238		043245		043252	
MH 5 Medeno hnedá RAL 8004	6,30	7,56	6,15	7,38	6,15	7,38	6,15	7,38	6,15	7,38
	042774		042781		042798		042804		042811	
SB 6 Šedo biela RAL 9002			6,15	7,38	6,15	7,38			6,15	7,38
			043504		043511				043528	
BH 7 Bielo hliníková RAL 9006			6,15	7,38	6,15	7,38	6,15	7,38	6,15	7,38
			042415		042422		042439		042446	
PS 8 Prachovo šedá RAL 7037					6,15	7,38			6,15	7,38
					043399				043405	
MM 9 Metalická medená RAL extra					6,50	7,80			6,50	7,80
					042934				042941	
BHT – P.20 10 Bielo hliníková tmavá RAL 9007					7,50	9,00				
					095466					
MZ 11 Machovo zelená RAL 6005					6,50	7,80			6,50	7,80
					043092				043108	
MOT 12 Tmavo modrá RAL 5010					6,50	7,80				
					043023					
TZ 13 Trávovo zelená RAL 6011					6,50	7,80				
					043832					
Balenie v m 📦										
Balenie v m 🚚	480		720		960		1 200		1 440	



STREŠNÝ ŽĽAB POLKRUHOVÝ [s=0,55]

P-PZ

Menovitá veľkosť	280		280		280		280		280		
	2,0		3,0		4,0		5,0		6,0		
Dĺžka v m											
Cena v €/m	Bez DPH	S DPH	Bez DPH	S DPH	Bez DPH	S DPH	Bez DPH	S DPH	Bez DPH	S DPH	
TM Testa di Moro RAL 8028	1	7,00	8,40	6,85	8,22	6,85	8,22	6,85	8,22	6,85	8,22
		043696		043702		043719		043726		043733	
AN Antracit RAL 7016	2	7,00	8,40	6,85	8,22	6,85	8,22	6,85	8,22	6,85	8,22
		042262		042279		042286		042293		042309	
IC Intenzívna čierna RAL 9005	3	7,00	8,40	6,85	8,22	6,85	8,22	6,85	8,22	6,85	8,22
		042620		042637		042644		042651		042668	
OC Oceľovo červená RAL 3009	4			6,85	8,22	6,85	8,22	6,85	8,22	6,85	8,22
				043269		043276		043283		043290	
MH Medeno hnedá RAL 8004	5			6,95	8,34	6,95	8,34			6,95	8,34
				042828		042835				042842	
SB Šedo biela RAL 9002	6					6,95	8,34			6,95	8,34
						043535				043542	
BH Bielo hliníková RAL 9006	7			6,95	8,34	6,95	8,34			6,95	8,34
				042453		042460				042477	
PS Prachovo šedá RAL 7037	8					6,95	8,34			6,95	8,34
						043412				043429	
MM Metalická medená RAL extra	9					7,45	8,94			7,45	8,94
						042958				042965	
BHT – P.20 Bielo hliníková tmavá RAL 9007	10					8,40	10,08				
						095473					
MZ Machovo zelená RAL 6005	11					7,45	8,94			7,45	8,94
						043115				043122	
MOT Tmavo modrá RAL 5010	12					7,45	8,94				
						043030					
TZ Trávovo zelená RAL 6011	13					7,45	8,94				
						043849					
Balenie v m 📦						20		25			
Balenie v m 🚚		420		630		840		1 050		1 260	

POZINK
POLYESTER



STREŠNÝ ŽLAB POLKRUHOVÝ [s=0,55]

P-PZ

Menovitá veľkosť	333		333		333		333		333	
	2,0		3,0		4,0		5,0		6,0	
Dĺžka v m	2,0		3,0		4,0		5,0		6,0	
	Bez DPH	S DPH	Bez DPH	S DPH	Bez DPH	S DPH	Bez DPH	S DPH	Bez DPH	S DPH
TM Testa di Moro RAL 8028	7,30	8,76	7,10	8,52	7,10	8,52	7,10	8,52	7,10	8,52
	043740		043757		043764		043771		043788	
AN Antracit RAL 7016	7,30	8,76	7,10	8,52	7,10	8,52	7,10	8,52	7,10	8,52
	042316		042323		042330		042347		042354	
IC Intenzívna čierna RAL 9005	7,30	8,76	7,10	8,52	7,10	8,52	7,10	8,52	7,10	8,52
	042675		042682		042699		042705		042712	
OC Oceľovo červená RAL 3009	7,30	8,76	7,10	8,52	7,10	8,52	7,10	8,52	7,10	8,52
	043306		043313		043320		043337		043344	
MH Medeno hnedá RAL 8004	7,40	8,88	7,20	8,64	7,20	8,64	7,20	8,64	7,20	8,64
	042859		042866		042873		042880		042897	
SB Šedo biela RAL 9002			7,20	8,64	7,20	8,64	7,20	8,64	7,20	8,64
			043559		043566		043573		043580	
BH Bielo hliníková RAL 9006			7,20	8,64	7,20	8,64	7,20	8,64	7,20	8,64
			042484		042491		042507		042514	
PS Prachovo šedá RAL 7037			7,20	8,64	7,20	8,64	7,20	8,64	7,20	8,64
			043436		043443		043450		043467	
MM Metalická medená RAL extra					8,30	9,96	8,30	9,96	8,30	9,96
					042972		042989		042996	
BHT – P.20 Bielo hliníková tmavá RAL 9007					8,50	10,20			8,50	10,20
					095480				095497	
MZ Machovo zelená RAL 6005					8,30	9,96	8,30	9,96	8,30	9,96
					043139		043146		043153	
MOT Tmavo modrá RAL 5010					8,30	9,96			8,30	9,96
					043047				043054	
TZ Trávovo zelená RAL 6011					8,30	9,96				
					043856					
Balenie v m 	10				20		25		30	
Balenie v m 	330		495		660		825		990	



STREŠNÝ ŽLAB POLKRUHOVÝ [s=0,55]
P-PZ

Menovitá veľkosť	400		400		500		500		333		
	Dĺžka v m		4,0		6,0		4,0		6,0		7,0
Cena v €/m	Bez DPH	S DPH	Bez DPH	S DPH	Bez DPH	S DPH	Bez DPH	S DPH	Bez DPH	S DPH	
	TM Testa di Moro RAL 8028	11,45	13,74	11,45	13,74					7,10	8,52
043801		043818						043795 *			
AN Antracit RAL 7016	11,45	13,74	11,45	13,74	15,50	18,60	15,50	18,60			
	042361		042378		086730 *		086747 *				
IC Intenzívna čierna RAL 9005	11,45	13,74	11,45	13,74							
	042729		042736								
OC Oceľovo červená RAL 3009	11,45	13,74	11,45	13,74							
	043351		043368								
MH Medeno hnedá RAL 8004	11,55	13,86	11,55	13,86							
	042903		042910								
SB Šedo biela RAL 9002	11,55	13,86	11,55	13,86	15,60	18,72	15,60	18,72			
	043597		043603		086778 *		086785 *				
BH Bielo hliníková RAL 9006	11,55	13,86	11,55	13,86	15,60	18,72	15,60	18,72			
	042521		042538		086754 *		086761 *				
PS Prachovo šedá RAL 7037	11,55	13,86	11,55	13,86							
	043474		043481								
MM Metalická medená RAL extra	12,15	14,58									
	043009										
BHT – P.20 Bielo hliníková tmavá RAL 9007			12,80	15,36							
			095503								
MZ Machovo zelená RAL 6005	12,15	14,58	12,15	14,58							
	043160		043177 *								
MOT Tmavo modrá RAL 5010	12,15	14,58	12,15	14,58							
	043061		043078								
TZ Trávovo zelená RAL 6011	12,15	14,58									
	043863 *										
Balenie v m 📦	20		30		-		-		35		
Balenie v m 🚚	540		810		-		-		1 155		

* Výroba na objednávku

 POZINK
 POLYESTER

NÁSTREŠNÝ ŽLAB SAMRÍNOVÝ [s=0,55]

P-PZS



Menovitá veľkosť	650		650	
	4,0		6,0	
Dĺžka v m	4,0		6,0	
Cena v €/m	Bez DPH	S DPH	Bez DPH	S DPH
TM 1 Testa di Moro RAL 8028	22,00	26,40	22,00	26,40
	049926		049933	
AN 2 Antracit RAL 7016	22,00	26,40	22,00	26,40
	049759		049766	
IC 3 Intenzívna čierna RAL 9005	22,00	26,40	22,00	26,40
	049797		049803	
OC 4 Oceľovo červená RAL 3009	22,00	26,40	22,00	26,40
	049865		049872	
MH 5 Medeno hnedá RAL 8004	22,80	27,36	22,80	27,36
	049810		049827	
SB 6 Šedo biela RAL 9002	22,80	27,36		
	049902			
BH 7 Bielo hliníková RAL 9006	22,80	27,36	22,80	27,36
	049773		049780	
PS 8 Prachovo šedá RAL 7037	22,80	27,36		
	049889			
MM 9 Metalická medená RAL extra	25,20	30,24		
	049834			
BHT – P.20 10 Bielo hliníková tmavá RAL 9007	29,25	35,10		
	095749 *			
MZ 11 Machovo zelená RAL 6005	25,20	30,24		
	049858			
MOT 12 Tmavo modrá RAL 5010	25,20	30,24		
	049841 *			
TZ 13 Trávovo zelená RAL 6011	25,20	30,24		
	049940 *			
Balenie v m 	4		6	
Balenie v m 	400		300	

* Výroba na objednávku



STREŠNÝ DILATAČNÝ ŽLAB POLKRUHOVÝ

P-PZDI

Menovitá veľkosť	250/260		280/260		333/260		400/260	
	Bez DPH	S DPH	Bez DPH	S DPH	Bez DPH	S DPH	Bez DPH	S DPH
TM 1 Testa di Moro RAL 8028	14,60	17,52	15,50	18,60	16,90	20,28	19,90	23,88
	013064		013071		013088		013095	
AN 2 Antracit RAL 7016	14,60	17,52	15,50	18,60	16,90	20,28	19,90	23,88
	012661		012678		012685		012692	
IC 3 Intenzívna čierna RAL 9005	14,60	17,52	15,50	18,60	16,90	20,28	19,90	23,88
	012746 *		012753 *		012760		012777 *	
OC 4 Oceľovo červená RAL 3009	14,60	17,52	15,50	18,60	16,90	20,28	19,90	23,88
	012944 *		012951 *		012968 *		012975 *	
MH 5 Medeno hnedá RAL 8004	14,60	17,52	15,50	18,60	16,90	20,28	19,90	23,88
	012784 *		012791 *		012807 *		012814 *	
SB 6 Šedo biela RAL 9002	14,60	17,52	15,50	18,60	16,90	20,28	19,90	23,88
	013026 *		013033 *		013040 *		013057 *	
BH 7 Bielo hliníková RAL 9006	14,60	17,52	15,50	18,60	16,90	20,28	19,90	23,88
	012708 *		012715 *		012722 *		012739 *	
PS 8 Prachovo šedá RAL 7037	14,60	17,52	15,50	18,60	16,90	20,28	19,90	23,88
	012982 *		012999 *		013002 *		013019 *	
MM 9 Metalická medená RAL extra	14,60	17,52	15,50	18,60	16,90	20,28	19,90	23,88
	012821 *		012838 *		012845 *		012852 *	
BHT – P.20 10 Bielo hliníková tmavá RAL 9007	14,60	17,52	15,50	18,60	16,90	20,28	19,90	23,88
	096098 *		096104 *		096111 *		114044 *	
MZ 11 Machovo zelená RAL 6005	14,60	17,52	15,50	18,60	16,90	20,28	19,90	23,88
	012906 *		012913 *		012920 *		012937 *	
MOT 12 Tmavo modrá RAL 5010	14,60	17,52	15,50	18,60	16,90	20,28	19,90	23,88
	012869 *		012876 *		012883 *		012890 *	
TZ 13 Trávovo zelená RAL 6011	14,60	17,52	15,50	18,60	16,90	20,28	19,90	23,88
	013101 *		013118 *		013125 *		013132 *	
Balenie v ks 	3		3		5		5	
Balenie v ks 	360		360		200		200	

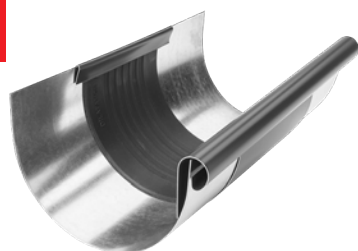

* Výroba na objednávku



DILATAČNÝ ŽĽAB NÁSTREŠNÝ – SAMRÍNA

P-PZSDI





Menovitá veľkosť	670/260	
	Bez DPH	S DPH
TM 1 Testa di Moro RAL 8028	31,50	37,80
	013637 *	
AN 2 Antracit RAL 7016	31,50	37,80
	013545 *	
IC 3 Intenzívna čierna RAL 9005	31,50	37,80
	013569 *	
OC 4 Oceľovo červená RAL 3009	31,50	37,80
	013606 *	
MH 5 Medeno hnedá RAL 8004	31,50	37,80
	013576 *	
SB 6 Šedo biela RAL 9002	31,50	37,80
	013620 *	
BH 7 Bielo hliníková RAL 9006	31,50	37,80
	013552 *	
PS 8 Prachovo šedá RAL 7037	31,50	37,80
	013613 *	
MM 9 Metalická medená RAL extra	31,50	37,80
	013583 *	
BHT – P.20 10 Bielo hliníková tmavá RAL 9007	31,50	37,80
	096067 *	
MZ 11 Machovo zelená RAL 6005	31,50	37,80
	013651 *	
MOT 12 Tmavo modrá RAL 5010	31,50	37,80
	013590 *	
TZ 13 Trávovo zelená RAL 6011	31,50	37,80
	013644 *	
Balenie v ks 	1	
Balenie v ks 	40	

* Výroba na objednávku

DILATAČNÝ PÁS

P-PZDIP



Menovitá veľkosť	Dĺžka v m	EAN číslo výrobku	Balenie v m		Cena [€/m]	
					Bez DPH	S DPH
260	3,0	012470	3	120	33,60	40,32
260	6,0	012487	6	240	33,60	40,32

POUŽITIE DILATAČNÉHO ŽĽABU A DILATAČNÉHO PÁSU

DILATAČNÝ ŽĽAB

Príklad montáže: Pododkvapový žľab o rozvinutej šírke do 500 mm. Dilatačný žľab musí byť namontovaný v rozostupe 15 m. Pre vonkajší roh a začiatok žľabu platí polovica štandardnej hodnoty: maximálne 7,5 m. Pre vnútorný roh platí štvrtina štandardnej hodnoty: maximálne 3,75 m. Pre ostatné materiály a rozmery: pozri tabuľku nižšie. Rohy sa vždy počítajú ako pevné body.

POLKRUHOVÉ DILATAČNÉ ŽĽABY

Rozvinutá šírka žľabu	Hliník	Pozink, Titán-zinok, Meď, Nerez
< 500	12	15
> 500	8	10

DILATAČNÝ PÁS

Vnútorňa inštalácia: na žľaby uchytené bez lepenia na podklad, strechy s neštandardným profilom a oplechovania muríva

DILATAČNÝ PÁS

Rozvinutá šírka žľabu	Hliník	Pozink, Titán-zinok, Meď, Nerez
< 500	8	10
> 500	6	8

Pre vonkajší roh alebo začiatok žľabu platí polovica štandardnej hodnoty. Pre vnútorný roh platí jedna štvrtina štandardnej hodnoty.

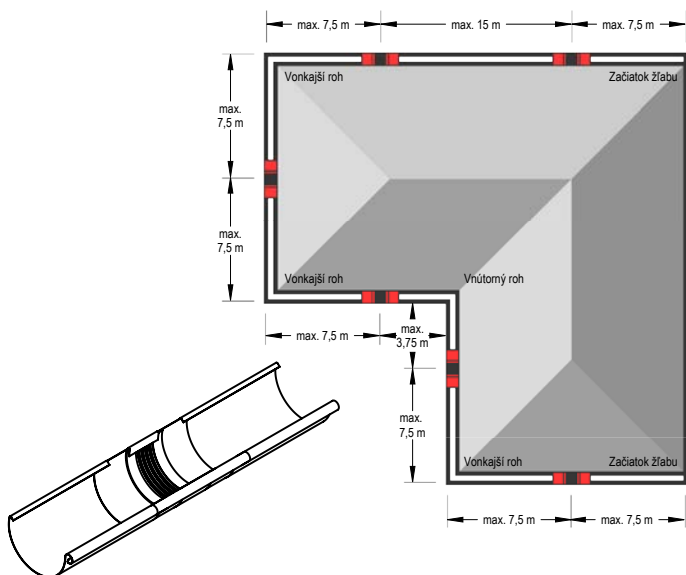

Poznámka k montáži dilatačného žľabu.

Pri montáži pomocou spájkovania najprv stredný gumový diel prekryte mokrou handričkou (aby nedošlo k prestupu tepla do stredného gumového dielu). Musí sa dodržať minimálna vzdialenosť 6 cm od strednej gumovej časti. V každom prípade sa treba vyhýbať kontaktu gumeného dielu s otvoreným plameňom.

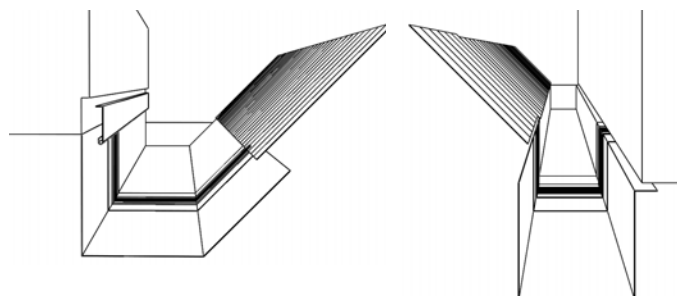

Poznámka k montáži dilatačného pásu.

Pri ohýbaní a montáži dilatačných prvkov sa uistite, že:

- Ohýbacie čeluste majú rádius minimálne 2 mm.
- Pre hrúbku plechu od 1 mm musí byť dodržaný polomer ohybu minimálne 5 mm.
- Ohýbacie čeluste musia byť pri ohýbaní nastavené na hrúbku strednej gumovej časti 3 až 4 mm, aby sa zabránilo strihaciemu efektu – poškodeniu gumeného dielu.
- Gumová stredná časť nesmie byť počas ohýbania stlačená alebo poškodená. Preto by mal byť použitý hliníkový plechový pás 2 až 5 mm (hrubý) ohnutý tak, aby mohol byť pripevnený ako ochrana na ohýbacie čeluste. Tým sa dosiahne väčší polomer ohybu a zabráni sa porušeniu gumovej strednej časti.

HLINÍKOVÁ MRIEŽKA ZACHYTÁVAČA NEČISTÔT

P-PZNL M

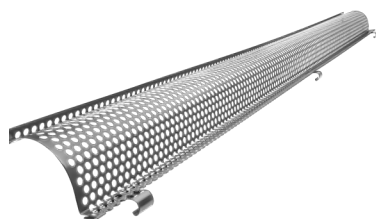



Menovitá veľkosť	333	
Dĺžka v m	2,0	
Cena v €/ks	Bez DPH	S DPH
TM 1 Testa di Moro RAL 8028	26,50	31,80
	064943	
AN 2 Antracit RAL 7016	26,50	31,80
	064912	
IC 3 Intenzívna čierna RAL 9005	26,50	31,80
	064929 *	
OC 4 Oceľovo červená RAL 3009	26,50	31,80
	064936 *	
MH 5 Medeno hnedá RAL 8004	26,50	31,80
	119766 *	
SB 6 Šedo biela RAL 9002	26,50	31,80
	117762 *	
BH 7 Bielo hliníková RAL 9006	26,50	31,80
	117717 *	
PS 8 Prachovo šedá RAL 7037	26,50	31,80
	117755 *	
MM 9 Metalická medená RAL extra	26,50	31,80
	117724 *	
BHT – P.20 10 Bielo hliníková tmavá RAL 9007	26,50	31,80
	097156 *	
MZ 11 Machovo zelená RAL 6005	26,50	31,80
	117748 *	
MOT 12 Tmavo modrá RAL 5010	26,50	31,80
	117731 *	
TZ 13 Trávovo zelená RAL 6011	26,50	31,80
	117779 *	
Balenie v ks	15	
Balenie v ks	120	

* Výroba na objednávku

POZINK POLYESTER



PVC MRIEŽKA ZACHYTÁVAČA LÍSTIA

SD-ZNL MRIEZKA

Menovitá veľkosť	Dĺžka v m	EAN číslo výrobku	Balenie v ks		Cena [€/ks]	
					Bez DPH	S DPH
PS 171	1,0	008473	30	450	4,50	5,40
TM 171	1,0	008466	30	450	4,50	5,40

PVC MRIEŽKA ZACHYTÁVAČA LÍSTIA

SD-ZNL N

Menovitá veľkosť	Dĺžka v m	EAN číslo výrobku	Balenie v ks		Cena [€/ks]	
					Bez DPH	S DPH
250	3,0	008480	10	400	23,90	28,68
280-333	3,0	008497	10	400	24,00	28,80

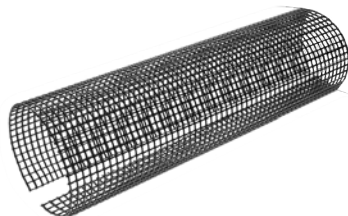
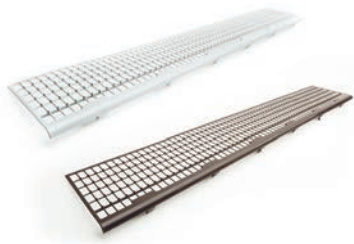

DRŽIAK NÁVALKY STREŠNÉHO ŽLABU

P-PDZNV

Menovitá veľkosť	250-280		333		400	
	Rozmer v mm		20		22	
Cena v €/ks	Bez DPH	S DPH	Bez DPH	S DPH	Bez DPH	S DPH
	TM 1 Testa di Moro RAL 8028	1,60	1,92	1,60	1,92	1,60
085665		085672		085689 *		
AN 2 Antracit RAL 7016	1,60	1,92	1,60	1,92	1,60	1,92
	085290		085306		085313	
IC 3 Intenzívna čierna RAL 9005	1,60	1,92	1,60	1,92	1,60	1,92
	085351		085368		085375 *	
OC 4 Oceľovo červená RAL 3009	1,60	1,92	1,60	1,92	1,60	1,92
	085504		085573		085597 *	
MH 5 Medeno hnedá RAL 8004	1,60	1,92	1,60	1,92	1,60	1,92
	085382		085399		085405 *	
SB 6 Šedo biela RAL 9002	1,60	1,92	1,60	1,92	1,60	1,92
	085634 *		085641		085658 *	
BH 7 Bielo hliníková RAL 9006	1,60	1,92	1,60	1,92	1,60	1,92
	085320		085337		085344 *	
PS 8 Prachovo šedá RAL 7037	1,60	1,92	1,60	1,92	1,60	1,92
	085603		085610		085627 *	
MM 9 Metalická medená RAL extra	1,60	1,92	1,60	1,92	1,60	1,92
	085412 *		085429		085436 *	
BHT – P.20 10 Bielo hliníková tmavá RAL 9007	1,60	1,92	1,60	1,92	1,60	1,92
	094636 *		094643 *		094650 *	
MZ 11 Machovo zelená RAL 6005	1,60	1,92	1,60	1,92	1,60	1,92
	085474 *		085481 *		085498 *	
MOT 12 Tmavo modrá RAL 5010	1,60	1,92	1,60	1,92	1,60	1,92
	085443 *		085450 *		085467 *	
TZ 13 Trávovo zelená RAL 6011	1,60	1,92	1,60	1,92	1,60	1,92
	085696 *		085702 *		085719 *	
Balenie v ks 	25		25		25	
Balenie v ks 	3 000		3 000		3 000	

* Výroba na objednávku



SPOJKA STREŠNÉHO ŽLABU

P-PSPZ

Menovitá veľkosť	250		280		333	
	Bez DPH	S DPH	Bez DPH	S DPH	Bez DPH	S DPH
TM 1 Testa di Moro RAL 8028	3,80	4,56	3,80	4,56	4,00	4,80
	083852		083869		083876	
AN 2 Antracit RAL 7016	3,80	4,56	3,80	4,56	4,00	4,80
	083456		083463		083470	
IC 3 Intenzívna čierna RAL 9005	3,80	4,56	3,80	4,56	4,00	4,80
	083531		083548		083555	
OC 4 Oceľovo červená RAL 3009	3,80	4,56	3,80	4,56	4,00	4,80
	083739		083746		083753	
MH 5 Medeno hnedá RAL 8004	3,80	4,56	3,80	4,56	4,00	4,80
	083579		083586		083593	
SB 6 Šedo biela RAL 9002	3,80	4,56	3,80	4,56	4,00	4,80
	083814		083821		083838	
BH 7 Bielo hliníková RAL 9006	3,80	4,56	3,80	4,56	4,00	4,80
	083494		083500		083517	
PS 8 Prachovo šedá RAL 7037	3,80	4,56	3,80	4,56	4,00	4,80
	083777		083784		083791	
MM 9 Metalická medená RAL extra	3,80	4,56	3,80	4,56	4,00	4,80
	083616		083623		083630	
BHT – P.20 10 Bielo hliníková tmavá RAL 9007	3,80	4,56	3,80	4,56	4,00	4,80
	094681		094698 *		094704	
MZ 11 Machovo zelená RAL 6005	3,80	4,56	3,80	4,56	4,00	4,80
	083692		083708		083715	
MOT 12 Tmavo modrá RAL 5010	3,80	4,56	3,80	4,56	4,00	4,80
	083654		083661		083678	
TZ 13 Trávovo zelená RAL 6011	3,80	4,56	3,80	4,56	4,00	4,80
	083890 *		083906 *		083913	
Balenie v ks 📦	5		5		5	
Balenie v ks 🚚	600		600		600	

* Výroba na objednávku



STREŠNÝ ŽLABOVÝ HÁK S PRELISOM

P-PHP

Menovitá veľkosť	200/380		250/430		280/480		280/480		
	Materiál		25/4		25/5		25/5		30/5
Cena v €/ks	Bez DPH	S DPH	Bez DPH	S DPH	Bez DPH	S DPH	Bez DPH	S DPH	
	TM Testa di Moro RAL 8028	3,30	3,96	2,95	3,54	3,15	3,78	3,45	4,14
045362		045379		045386		045393			
AN Antracit RAL 7016	3,30	3,96	2,95	3,54	3,15	3,78	3,45	4,14	
	044648		044655		044662		044679		
IC Intenzívna čierna RAL 9005	3,30	3,96	2,95	3,54	3,15	3,78	3,45	4,14	
	044808		044815		044822		044839		
OC Oceľovo červená RAL 3009	3,30	3,96	2,95	3,54	3,15	3,78	3,45	4,14	
	045140		045157		045164		045171		
MH Medeno hnedá RAL 8004	3,30	3,96	2,95	3,54	3,15	3,78	3,45	4,14	
	044884		044891		044907		044914		
SB Šedo biela RAL 9002	3,30	3,96	2,95	3,54	3,15	3,78	3,45	4,14	
	045287		045294		045300		045317		
BH Bielo hliníková RAL 9006	3,30	3,96	2,95	3,54	3,15	3,78	3,45	4,14	
	044723		044730		044747		044754		
PS Prachovo šedá RAL 7037	3,30	3,96	2,95	3,54			3,45	4,14	
	045225		045232				045249		
MM Metalická medená RAL extra	3,30	3,96	2,95	3,54			3,45	4,14	
	044969		044976				044983		
BHT – P.20 Bielo hliníková tmavá RAL 9007			2,95	3,54			3,45	4,14	
			095961				095978		
MZ Machovo zelená RAL 6005	3,30	3,96	2,95	3,54			3,45	4,14	
	045089		045096				045102		
MOT Tmavo modrá RAL 5010	3,30	3,96	2,95	3,54			3,45	4,14	
	045027		045034				045041		
TZ Trávovo zelená RAL 6011	3,30	3,96	2,95	3,54			3,45	4,14	
	045454 *		045461				045478		
Balenie v ks 📦	25		25		25		25		
Balenie v ks 🚚	1 000		1 000		1 000		1 000		

* Výroba na objednávku



STREŠNÝ ŽLABOVÝ HÁK S PRELISOM

P-PHP

Menovitá veľkosť	333/550		333/550		333/550		333/610		400/610	
Materiál	25/5		30/4		30/5		30/5		25/5	
Cena v €/ks	Bez DPH	S DPH	Bez DPH	S DPH	Bez DPH	S DPH	Bez DPH	S DPH	Bez DPH	S DPH
TM Testa di Moro RAL 8028	3,15	3,78	3,30	3,96	3,50	4,20	4,10	4,92	5,90	7,08
	045409		045416 *		045423		045430		045447	
AN Antracit RAL 7016	3,15	3,78	3,30	3,96	3,50	4,20	4,10	4,92	5,90	7,08
	044686		080127 *		044693		044709		044716	
IC Intenzívna čierna RAL 9005	3,15	3,78			3,50	4,20	4,10	4,92	5,90	7,08
	044846				044853		044860		044877	
OC Oceľovo červená RAL 3009	3,15	3,78			3,50	4,20	4,10	4,92	5,90	7,08
	045188				045195		045201		045218	
MH Medeno hnedá RAL 8004	3,15	3,78			3,50	4,20	4,10	4,92	5,90	7,08
	044921				044938		044945		044952 *	
SB Šedo biela RAL 9002	3,15	3,78			3,50	4,20	4,10	4,92	5,90	7,08
	045324				045331		045348		045355	
BH Bielo hliníková RAL 9006	3,15	3,78			3,50	4,20	4,10	4,92	5,90	7,08
	044761				044778		044785		044792	
PS Prachovo šedá RAL 7037					3,50	4,20	4,10	4,92	5,90	7,08
					045256		045263		045270	
MM Metalická medená RAL extra					3,50	4,20	4,10	4,92	5,90	7,08
					044990		045003		045010	
BHT – P.20 Bielo hliníková tmavá RAL 9007					3,50	4,20			5,90	7,08
					095985				095992	
MZ Machovo zelená RAL 6005					3,50	4,20	4,10	4,92	5,90	7,08
					045119		045126		045133	
MOT Tmavo modrá RAL 5010					3,50	4,20	4,10	4,92	5,90	7,08
					045058		045065		045072	
TZ Trávovo zelená RAL 6011					3,50	4,20	4,10	4,92	5,90	7,08
					045485		045492		045508 *	
Balenie v ks 	25		25		25		25		25	
Balenie v ks 	1 000		1 000		1 000		1 000		500	

* Výroba na objednávku



STREŠNÝ ŽLABOVÝ HÁK POLKRUHOVÝ NOS

P-PHPN

Menovitá veľkosť	250/430		280/480		333/550	
Materiál	25/5		25/5		25/5	
Cena v €/ks	Bez DPH	S DPH	Bez DPH	S DPH	Bez DPH	S DPH
TM 1 Testa di Moro RAL 8028	2,90	3,48	2,90	3,48	3,20	3,84
	095930		095947		095954	
AN 2 Antracit RAL 7016	2,90	3,48	2,90	3,48	3,20	3,84
	095824		095831		095848	
IC 3 Intenzívna čierna RAL 9005			2,90	3,48	3,20	3,84
			095879		095886 *	
MH 5 Medeno hnedá RAL 8004			2,90	3,48	3,20	3,84
			095893		095909	
SB 6 Šedo biela RAL 9002			2,90	3,48	3,20	3,84
			095916		095923 *	
BH 7 Bielo hliníková RAL 9006			2,90	3,48	3,20	3,84
			095855		095862	
PS 8 Prachovo šedá RAL 7037					3,20	3,84
					117496 *	
Balenie v ks 📦	25		25		25	
Balenie v ks 🚚	1 000		1 000		1 000	

* Výroba na objednávku

STREŠNÝ ŽLABOVÝ HÁK NOS KROKVA

P-PHPNK



Menovitá veľkosť	250		280		333	
Materiál	25/4		25/4		25/5	
Cena v €/ks	Bez DPH	S DPH	Bez DPH	S DPH	Bez DPH	S DPH
TM 1 Testa di Moro RAL 8028	3,15	3,78	3,35	4,02	3,55	4,26
	095435		095442		095459	
AN 2 Antracit RAL 7016	3,15	3,78	3,35	4,02	3,55	4,26
	095312		095329		095336	
IC 3 Intenzívna čierna RAL 9005	3,15	3,78	3,35	4,02	3,55	4,26
	095374		095381		095398	
MH 5 Medeno hnedá RAL 8004	3,15	3,78	3,35	4,02	3,55	4,26
	095404		095411		095428	
BH 7 Bielo hliníková RAL 9006	3,15	3,78	3,35	4,02	3,55	4,26
	095343 *		095350		095367	
Balenie v ks 📦	25		25		25	
Balenie v ks 🚚	1 000		1 000		1 000	

* Výroba na objednávku



NÁSTREŠNÝ HÁK SAMRÍNOVÝ SPEVNENÝ

P-PHSSN

Menovitá veľkosť	4	
Materiál	20/6	
Cena v €/ks	Bez DPH	S DPH
TM 1 Testa di Moro RAL 8028	8,60	10,32
	033567	
AN 2 Antracit RAL 7016	8,60	10,32
	033468	
IC 3 Intenzívna čierna RAL 9005	8,60	10,32
	033482	
OC 4 Oceľovo červená RAL 3009	8,60	10,32
	033536	
MH 5 Medeno hnedá RAL 8004	8,60	10,32
	033499	
SB 6 Šedo biela RAL 9002	8,60	10,32
	033550	
BH 7 Bielo hliníková RAL 9006	8,60	10,32
	033475	
PS 8 Prachovo šedá RAL 7037	8,60	10,32
	033543	
MM 9 Metalická medená RAL extra	8,60	10,32
	033505	
BHT – P.20 10 Bielo hliníková tmavá RAL 9007	8,60	10,32
	095510 *	
MZ 11 Machovo zelená RAL 6005	8,60	10,32
	033529	
MOT 12 Tmavo modrá RAL 5010	8,60	10,32
	033512 *	
TZ 13 Trávovo zelená RAL 6011	8,60	10,32
	033574	
Balenie v ks 	25	
Balenie v ks 	1 000	

* Výroba na objednávku



POZINK
POLYESTER



STREŠNÝ ŽLABOVÝ HÁK KROKVA

P-PHPK





Menovitá veľkosť	200		250		280		333		400	
Materiál	25/4		25/4		25/4		25/5		30/5	
Cena v €/ks	Bez DPH	S DPH	Bez DPH	S DPH	Bez DPH	S DPH	Bez DPH	S DPH	Bez DPH	S DPH
TM Testa di Moro RAL 8028	3,60	4,32	3,40	4,08	3,65	4,38	3,95	4,74	5,50	6,60
	065551		065568		065575		065582		065599	
AN Antracit RAL 7016	3,60	4,32	3,40	4,08	3,65	4,38	3,95	4,74	5,50	6,60
	065056		065063		065070		065087		065094	
IC Intenzívna čierna RAL 9005	3,60	4,32	3,40	4,08	3,65	4,38	3,95	4,74	5,50	6,60
	065155		065162		065179		065186		065193 *	
OC Oceľovo červená RAL 3009	3,60	4,32	3,40	4,08	3,65	4,38	3,95	4,74	5,50	6,60
	065407		065414		065421		065438		065445	
MH Medeno hnedá RAL 8004	3,60	4,32	3,40	4,08	3,65	4,38	3,95	4,74	5,50	6,60
	065209		065216		065223		065230		065247 *	
SB Šedo biela RAL 9002	3,60	4,32	3,40	4,08	3,65	4,38	3,95	4,74	5,50	6,60
	065506		065513		065520		065537		065544	
BH Bielo hliníková RAL 9006	3,60	4,32	3,40	4,08	3,65	4,38	3,95	4,74	5,50	6,60
	065100		065117		065124		065131		065148	
PS Prachovo šedá RAL 7037	3,60	4,32	3,40	4,08	3,65	4,38	3,95	4,74	5,50	6,60
	065452		065469		065476		065483		065490	
MM Metalická medená RAL extra	3,60	4,32	3,40	4,08	3,65	4,38	3,95	4,74	5,50	6,60
	065254		065261		065278		065285		065292 *	
BHT – P.20 Bielo hliníková tmavá RAL 9007			3,40	4,08	3,65	4,38	3,95	4,74		
			095251		095268		095275			
MZ Machovo zelená RAL 6005	3,60	4,32	3,40	4,08	3,65	4,38	3,95	4,74	5,50	6,60
	065353		065360		065377		065384		065391 *	
MOT Tmavo modrá RAL 5010	3,60	4,32	3,40	4,08	3,65	4,38	3,95	4,74	5,50	6,60
	065308 *		065315		065322		065339		065346	
TZ Trávovo zelená RAL 6011	3,60	4,32	3,40	4,08	3,65	4,38	3,95	4,74	5,50	6,60
	065605 *		065612 *		065629 *		065636 *		065643 *	
Balenie v ks 	25		25		25		25		20	
Balenie v ks 	1 000		1 000		1 000		1 000		800	

* Výroba na objednávku

ŽLABOVÝ ROH VONKAJŠÍ

P-PRA

Menovitá veľkosť	200		250		280		333		400	
	Bez DPH	S DPH	Bez DPH	S DPH	Bez DPH	S DPH	Bez DPH	S DPH	Bez DPH	S DPH
TM 1 Testa di Moro RAL 8028	11,90	14,28	11,70	14,04	11,80	14,16	11,90	14,28	29,90	35,88
	075673		075680		075697		075703		075710	
AN 2 Antracit RAL 7016	11,90	14,28	11,70	14,04	11,80	14,16	11,90	14,28	29,90	35,88
	075178		075185		075192		075208		075215	
IC 3 Intenzívna čierna RAL 9005	11,90	14,28	11,70	14,04	11,80	14,16	11,90	14,28	29,90	35,88
	075260		075284		075291		075307		075314	
OC 4 Oceľovo červená RAL 3009	11,90	14,28	11,70	14,04	11,80	14,16	11,90	14,28	29,90	35,88
	075529		075536		075543		075567		075550	
MH 5 Medeno hnedá RAL 8004	11,90	14,28	11,70	14,04	11,80	14,16	11,90	14,28	29,90	35,88
	075321		075338		075345		075352		075369	
SB 6 Šedo biela RAL 9002	11,90	14,28	11,70	14,04	11,80	14,16	11,90	14,28	29,90	35,88
	075635		075628		075642		075659		075666	
BH 7 Bielo hliníková RAL 9006	11,90	14,28	11,70	14,04	11,80	14,16	11,90	14,28	29,90	35,88
	075222		075239		075246		075253		075277	
PS 8 Prachovo šedá RAL 7037	11,90	14,28	11,70	14,04	11,80	14,16	11,90	14,28	29,90	35,88
	075574		075581		075598		075604		075611	
MM 9 Metalická medená RAL extra	11,90	14,28	11,70	14,04	11,80	14,16	11,90	14,28	29,90	35,88
	075376		075383		075390		075406		075413	
BHT – P.20 10 Bielo hliníková tmavá RAL 9007			11,70	14,04	11,80	14,16	11,90	14,28	29,90	35,88
			094384		094391 *		094407		110695	
MZ 11 Machovo zelená RAL 6005	11,90	14,28	11,70	14,04	11,80	14,16	11,90	14,28	29,90	35,88
	075475		075482		075499		075505		075512	
MOT 12 Tmavo modrá RAL 5010	11,90	14,28	11,70	14,04	11,80	14,16	11,90	14,28	29,90	35,88
	075420		075437		075444		075451		075468	
TZ 13 Trávovo zelená RAL 6011	11,90	14,28	11,70	14,04	11,80	14,16	11,90	14,28	29,90	35,88
	075727 *		075734		075741		075758		075765 *	
Balenie v ks 	5		5		5		5		5	
Balenie v ks 	150		150		150		150		150	

* Výroba na objednávku

POZINK
POLYESTER



ŽLABOVÝ ROH VNÚTORNÝ

P-PRI



Menovitá veľkosť	200		250		280		333		400	
	Bez DPH	S DPH	Bez DPH	S DPH	Bez DPH	S DPH	Bez DPH	S DPH	Bez DPH	S DPH
TM 1 Testa di Moro RAL 8028	11,90	14,28	11,70	14,04	11,80	14,16	11,90	14,28	29,90	35,88
	076281		076274		076298		076304		076311	
AN 2 Antracit RAL 7016	11,90	14,28	11,70	14,04	11,80	14,16	11,90	14,28	29,90	35,88
	075772		075789		075796		075802		075819	
IC 3 Intenzívna čierna RAL 9005	11,90	14,28	11,70	14,04	11,80	14,16	11,90	14,28	29,90	35,88
	075871		075888		075895		075901		075918	
OC 4 Oceľovo červená RAL 3009	11,90	14,28	11,70	14,04	11,80	14,16	11,90	14,28	29,90	35,88
	076120		076137		076144		076168		076151	
MH 5 Medeno hnedá RAL 8004	11,90	14,28	11,70	14,04	11,80	14,16	11,90	14,28	29,90	35,88
	075925		075932		075949		075956		075963	
SB 6 Šedo biela RAL 9002	11,90	14,28	11,70	14,04	11,80	14,16	11,90	14,28	29,90	35,88
	076229		076236		076243		076250		076267	
BH 7 Bielo hliníková RAL 9006	11,90	14,28	11,70	14,04	11,80	14,16	11,90	14,28	29,90	35,88
	075826		075833		075840		075857		075864	
PS 8 Prachovo šedá RAL 7037	11,90	14,28	11,70	14,04	11,80	14,16	11,90	14,28	29,90	35,88
	076175		076199		076182		076205		076212	
MM 9 Metalická medená RAL extra	11,90	14,28	11,70	14,04	11,80	14,16	11,90	14,28	29,90	35,88
	075970		075987		075994		076007		076014	
BHT – P.20 10 Bielo hliníková tmavá RAL 9007			11,70	14,04	11,80	14,16	11,90	14,28	29,90	35,88
			094414		094421 *		094438		110688	
MZ 11 Machovo zelená RAL 6005	11,90	14,28	11,70	14,04	11,80	14,16	11,90	14,28	29,90	35,88
	076076		076083		076090		076106		076113	
MOT 12 Tmavo modrá RAL 5010	11,90	14,28	11,70	14,04	11,80	14,16	11,90	14,28	29,90	35,88
	076021 *		076038		076045		076052		076069	
TZ 13 Trávovo zelená RAL 6011	11,90	14,28	11,70	14,04	11,80	14,16	11,90	14,28	29,90	35,88
	076335 *		076328		076342		076359		076366 *	
Balenie v ks 📦	5		5		5		5		5	
Balenie v ks 🚚	150		150		150		150		150	

* Výroba na objednávku



ŽLABOVÉ ČELO POLKRUHOVÉ

P-PCL



Menovitá veľkosť	200		250		280		333		400	
	Bez DPH	S DPH	Bez DPH	S DPH	Bez DPH	S DPH	Bez DPH	S DPH	Bez DPH	S DPH
TM 1 Testa di Moro RAL 8028	1,45	1,74	1,30	1,56	1,40	1,68	1,45	1,74	2,25	2,70
	003164		003171		003188		003195		003201	
AN 2 Antracit RAL 7016	1,45	1,74	1,30	1,56	1,40	1,68	1,45	1,74	2,25	2,70
	002662		002679		002686		002693		002709	
IC 3 Intenzívna čierna RAL 9005	1,45	1,74	1,30	1,56	1,40	1,68	1,45	1,74	2,25	2,70
	002761		002778		002785		002792		002808	
OC 4 Oceľovo červená RAL 3009	1,45	1,74	1,30	1,56	1,40	1,68	1,45	1,74	2,25	2,70
	003010		003027		003034		003041		003058	
MH 5 Medeno hnedá RAL 8004	1,45	1,74	1,30	1,56	1,40	1,68	1,45	1,74	2,25	2,70
	002815		002822		002839		002846		002853	
SB 6 Šedo biela RAL 9002	1,45	1,74	1,30	1,56	1,40	1,68	1,45	1,74	2,25	2,70
	003119		003126		003133		003140		003157	
BH 7 Bielo hliníková RAL 9006	1,45	1,74	1,30	1,56	1,40	1,68	1,45	1,74	2,25	2,70
	002716		002723		002730		002747		002754	
PS 8 Prachovo šedá RAL 7037	1,45	1,74	1,30	1,56	1,40	1,68	1,45	1,74	2,25	2,70
	003065		003072		003089		003096		003102	
MM 9 Metalická medená RAL extra	1,45	1,74	1,30	1,56	1,40	1,68	1,45	1,74	2,25	2,70
	002860		002877		002884		002891		002907	
BHT – P.20 10 Bielo hliníková tmavá RAL 9007			1,30	1,56	1,40	1,68	1,45	1,74	2,25	2,70
			094568		094575 *		094582		094599	
MZ 11 Machovo zelená RAL 6005	1,45	1,74	1,30	1,56	1,40	1,68	1,45	1,74	2,25	2,70
	002969		002976		002983		002990		003003	
MOT 12 Tmavo modrá RAL 5010	1,45	1,74	1,30	1,56	1,40	1,68	1,45	1,74	2,25	2,70
	002914		002921		002938		002945		002952	
TZ 13 Trávovo zelená RAL 6011	1,45	1,74	1,30	1,56	1,40	1,68	1,45	1,74	2,25	2,70
	003218 *		003225		003232		003249		003256	
Balenie v ks 	6/60		6/60		6/60		6/60		4/40	
Balenie v ks 	1 440		1 440		1 440		1 440		960	

* Výroba na objednávku



ŽLABOVÉ ČELO S GUMOU

P-PCLG

Menovitá veľkosť	250		280		333	
	Bez DPH	S DPH	Bez DPH	S DPH	Bez DPH	S DPH
TM 1 Testa di Moro RAL 8028	2,65	3,18	2,90	3,48	3,00	3,60
	004338		004345		004352	
AN 2 Antracit RAL 7016	2,65	3,18	2,90	3,48	3,00	3,60
	004031		004048		004055	
IC 3 Intenzívna čierna RAL 9005	2,65	3,18	2,90	3,48	3,00	3,60
	004093		004109		004116	
OC 4 Oceľovo červená RAL 3009	2,65	3,18	2,90	3,48	3,00	3,60
	004246		004253		004260	
MH 5 Medeno hnedá RAL 8004	2,65	3,18	2,90	3,48	3,00	3,60
	004123		004130		004147	
SB 6 Šedo biela RAL 9002	2,65	3,18	2,90	3,48	3,00	3,60
	004307		004314		004321	
BH 7 Bielo hliníková RAL 9006	2,65	3,18	2,90	3,48	3,00	3,60
	004062		004079		004086	
PS 8 Prachovo šedá RAL 7037	2,65	3,18	2,90	3,48	3,00	3,60
	004277		004284		004291	
MM 9 Metalická medená RAL extra	2,65	3,18	2,90	3,48	3,00	3,60
	004154		004161		004178	
BHT – P.20 10 Bielo hliníková tmavá RAL 9007	2,65	3,18	2,90	3,48	3,00	3,60
	094605		094612 *		094629	
MZ 11 Machovo zelená RAL 6005	2,65	3,18	2,90	3,48	3,00	3,60
	004215		004222		004239	
MOT 12 Tmavo modrá RAL 5010	2,65	3,18	2,90	3,48	3,00	3,60
	004185		004192		004208	
TZ 13 Trávovo zelená RAL 6011	2,65	3,18	2,90	3,48	3,00	3,60
	004369 *		004376 *		004383 *	
Balenie v ks 	4/40		4/40		4/40	
Balenie v ks 	960		960		960	

* Výroba na objednávku



ŽLABOVÝ KOTLÍK

P-PKL

Menovitá veľkosť	200/60		250/60		250/80		280/80		280/100	
	Bez DPH	S DPH	Bez DPH	S DPH	Bez DPH	S DPH	Bez DPH	S DPH	Bez DPH	S DPH
TM 1 Testa di Moro RAL 8028	7,40	8,88	9,00	10,80	6,60	7,92	7,20	8,64	7,20	8,64
	067357		067364		067371		067388		067395	
AN 2 Antracit RAL 7016	7,40	8,88	9,00	10,80	6,60	7,92	7,20	8,64	7,20	8,64
	066251		066268		066275		066282		066299	
IC 3 Intenzívna čierna RAL 9005	7,40	8,88	9,00	10,80	6,60	7,92	7,20	8,64	7,20	8,64
	066473		066480		066497		066503		066510	
OC 4 Oceľovo červená RAL 3009	7,40	8,88	9,00	10,80	6,60	7,92	7,20	8,64	7,20	8,64
	067029		067036		067043		067050		067067	
MH 5 Medeno hnedá RAL 8004	7,40	8,88	9,00	10,80	6,60	7,92	7,20	8,64	7,20	8,64
	066589		066596		066602		066619		066626	
SB 6 Šedo biela RAL 9002	7,40	8,88	9,00	10,80	6,60	7,92	7,20	8,64	7,20	8,64
	067241		067258		067265		067272		067289	
BH 7 Bielo hliníková RAL 9006	7,40	8,88	9,00	10,80	6,60	7,92	7,20	8,64	7,20	8,64
	066367		066374		066381		066398		066404	
PS 8 Prachovo šedá RAL 7037	7,40	8,88	9,00	10,80	6,60	7,92	7,20	8,64	7,20	8,64
	067135		067142 *		067159		067166		067173	
MM 9 Metalická medená RAL extra	7,40	8,88	9,00	10,80	6,60	7,92	7,20	8,64	7,20	8,64
	066695		066701 *		066718		066725		066732	
BHT – P.20 10 Bielo hliníková tmavá RAL 9007	7,40	8,88	9,00	10,80	6,60	7,92	7,20	8,64	7,20	8,64
	119728 *		119735 *		094469		094476		094483	
MZ 11 Machovo zelená RAL 6005	7,40	8,88	9,00	10,80	6,60	7,92	7,20	8,64	7,20	8,64
	066916		066923		066930		066947		066954	
MOT 12 Tmavo modrá RAL 5010	7,40	8,88	9,00	10,80	6,60	7,92	7,20	8,64	7,20	8,64
	066800 *		066817 *		066824		066831		066848	
TZ 13 Trávovo zelená RAL 6011	7,40	8,88	9,00	10,80	6,60	7,92	7,20	8,64	7,20	8,64
	067463 *		067470 *		067487		067494 *		067500	
Balenie v ks 📦	20		20		20		20		20	
Balenie v ks 🚚	600		600		600		600		600	

* Výroba na objednávku



ŽLABOVÝ KOTLÍK

P-PKL



Menovitá veľkosť	333/80		333/100		333/120	
	Bez DPH	S DPH	Bez DPH	S DPH	Bez DPH	S DPH
TM 1 Testa di Moro RAL 8028	8,40	10,08	7,95	9,54	9,50	11,40
	067401		067418		067425	
AN 2 Antracit RAL 7016	8,40	10,08	7,95	9,54	9,50	11,40
	066305		066312		066329	
IC 3 Intenzívna čierna RAL 9005	8,40	10,08	7,95	9,54	9,50	11,40
	066527		066534		066541	
OC 4 Oceľovo červená RAL 3009	8,40	10,08	7,95	9,54	9,50	11,40
	067074		067081		067098	
MH 5 Medeno hnedá RAL 8004	8,40	10,08	7,95	9,54	9,50	11,40
	066633		066640		066657	
SB 6 Šedo biela RAL 9002	8,40	10,08	7,95	9,54	9,50	11,40
	067296		067302		067326	
BH 7 Bielo hliníková RAL 9006	8,40	10,08	7,95	9,54	9,50	11,40
	066411		066428		066435	
PS 8 Prachovo šedá RAL 7037	8,40	10,08	7,95	9,54	9,50	11,40
	067180		067197		067203	
MM 9 Metalická medená RAL extra	8,40	10,08	7,95	9,54	9,50	11,40
	066749		066756		066763	
BHT – P.20 10 Bielo hliníková tmavá RAL 9007	8,40	10,08	7,95	9,54	9,50	11,40
	094490 *		094506		094513	
MZ 11 Machovo zelená RAL 6005	8,40	10,08	7,95	9,54	9,50	11,40
	066961		066978		066985	
MOT 12 Tmavo modrá RAL 5010	8,40	10,08	7,95	9,54	9,50	11,40
	066855 *		066862		066879	
TZ 13 Trávovo zelená RAL 6011	8,40	10,08	7,95	9,54	9,50	11,40
	067517 *		067524		067531	
Balenie v ks 	20		20		15	
Balenie v ks 	600		600		300	

* Výroba na objednávku

ŽLABOVÝ KOTLÍK

P-PKL

Menovitá veľkosť	400/100		400/120		400/150	
	Bez DPH	S DPH	Bez DPH	S DPH	Bez DPH	S DPH
TM 1 Testa di Moro RAL 8028	19,00	22,80	19,00	22,80	21,50	25,80
	067432		067449		067456	
AN 2 Antracit RAL 7016	19,00	22,80	19,00	22,80	21,50	25,80
	066336		066343		066350	
IC 3 Intenzívna čierna RAL 9005	19,00	22,80	19,00	22,80	21,50	25,80
	066558		066565		066572	
OC 4 Oceľovo červená RAL 3009	19,00	22,80	19,00	22,80	21,50	25,80
	067104 *		067111		067128	
MH 5 Medeno hnedá RAL 8004	19,00	22,80	19,00	22,80	21,50	25,80
	066664 *		066671		066688	
SB 6 Šedo biela RAL 9002	19,00	22,80	19,00	22,80	21,50	25,80
	067319		067333		067340	
BH 7 Bielo hliníková RAL 9006	19,00	22,80	19,00	22,80	21,50	25,80
	066442		066459		066466	
PS 8 Prachovo šedá RAL 7037	19,00	22,80	19,00	22,80	21,50	25,80
	067210		067227		067234	
MM 9 Metalická medená RAL extra	19,00	22,80	19,00	22,80	21,50	25,80
	066770 *		066787 *		066794 *	
BHT – P.20 10 Bielo hliníková tmavá RAL 9007	19,00	22,80	19,00	22,80	21,50	25,80
	119742 *		094520		094667	
MZ 11 Machovo zelená RAL 6005	19,00	22,80	19,00	22,80	21,50	25,80
	066992 *		067005		067012	
MOT 12 Tmavo modrá RAL 5010	19,00	22,80	19,00	22,80	21,50	25,80
	066886 *		066893		066909	
TZ 13 Trávovo zelená RAL 6011	19,00	22,80	19,00	22,80	21,50	25,80
	067548 *		067555		067562 *	
Balenie v ks 	15		15		15	
Balenie v ks 	300		300		300	

* Výroba na objednávku



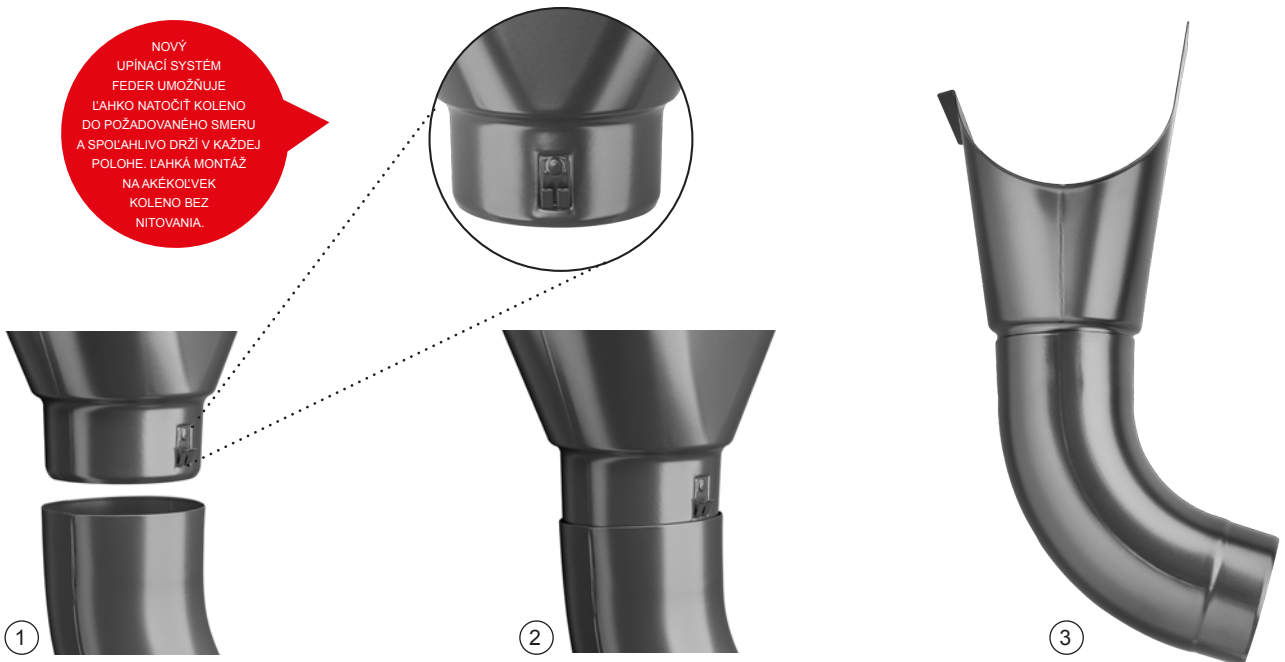

NOVÝ
UPINACÍ SYSTÉM
FEDER UMOŽŇUJE
LAHKO NATOČIT KOLENO
DO POŽADOVANÉHO SMERU
A SPOLIAHLIVO DRŽÍ V KAŽDEJ
POLOHE. LAHKÁ MONTÁŽ
NA AKÉKOLVEK
KOLENO BEZ
NITOVANIA.



STREŠNÉ ŽLABOVÉ HRDLO

P-PHRD

Menovitá veľkosť	80		100		120	
	Bez DPH	S DPH	Bez DPH	S DPH	Bez DPH	S DPH
TM 1 Testa di Moro RAL 8028	1,65	1,98	1,75	2,10	2,10	2,52
	066015		066022		066039	
AN 2 Antracit RAL 7016	1,65	1,98	1,75	2,10	2,10	2,52
	065711		065728		065735 *	
IC 3 Intenzívna čierna RAL 9005	1,65	1,98	1,75	2,10	2,10	2,52
	065773 *		065780		065797 *	
OC 4 Oceľovo červená RAL 3009	1,65	1,98	1,75	2,10	2,10	2,52
	065926 *		065933		065940 *	
MH 5 Medeno hnedá RAL 8004	1,65	1,98	1,75	2,10	2,10	2,52
	065803 *		065810		065827 *	
SB 6 Šedo biela RAL 9002	1,65	1,98	1,75	2,10	2,10	2,52
	065988 *		065995 *		066008 *	
BH 7 Bielo hliníková RAL 9006	1,65	1,98	1,75	2,10	2,10	2,52
	065742 *		065759 *		065766 *	
PS 8 Prachovo šedá RAL 7037	1,65	1,98	1,75	2,10	2,10	2,52
	065957 *		065964 *		065971 *	
MM 9 Metalická medená RAL extra	1,65	1,98	1,75	2,10	2,10	2,52
	065834 *		065841 *		065858 *	
BHT – P.20 10 Bielo hliníková tmavá RAL 9007						
MZ 11 Machovo zelená RAL 6005	1,65	1,98	1,75	2,10	2,10	2,52
	065896 *		065902 *		065919 *	
MOT 12 Tmavo modrá RAL 5010	1,65	1,98	1,75	2,10	2,10	2,52
	065865 *		065872 *		065889 *	
TZ 13 Trávovo zelená RAL 6011	1,65	1,98	1,75	2,10	2,10	2,52
	066046 *		066053 *		066060 *	
Balenie v ks 	25		25		15	
Balenie v ks 	1 000		1 000		750	



* Výroba na objednávku



NEREZOVÝ ZACHYTÁVAČ NEČISTÔT STREŠNÝCH ŽLABOV

N-NZN





Menovitá veľkosť	EAN číslo výrobku	Balenie v ks		Cena [€/ks]	
				Bez DPH	S DPH
60	001153	30	2 160	5,55	6,66
80	001160	20	1 440	5,60	6,72
100	001177	15	1 080	5,70	6,84
120	001184	10	720	6,20	7,44
150	001191	5	360	9,80	11,76



KOTLÍK ZBERNÝ DESIGN

P-PKLZ DE

Menovitá veľkosť	80		100		120	
	Bez DPH	S DPH	Bez DPH	S DPH	Bez DPH	S DPH
TM 1 Testa di Moro RAL 8028	58,00	69,60	58,00	69,60	64,00	76,80
	027702		027726		027740	
AN 2 Antracit RAL 7016	58,00	69,60	58,00	69,60	64,00	76,80
	026200		026224		026248	
IC 3 Intenzívna čierna RAL 9005	58,00	69,60	58,00	69,60	64,00	76,80
	026507		026521		026545	
OC 4 Oceľovo červená RAL 3009	58,00	69,60	58,00	69,60	64,00	76,80
	027252 *		027276		027290	
MH 5 Medeno hnedá RAL 8004	58,00	69,60	58,00	69,60	64,00	76,80
	026651		026675		026699	
SB 6 Šedo biela RAL 9002	58,00	69,60	58,00	69,60	64,00	76,80
	027559 *		027573		027597	
BH 7 Bielo hliníková RAL 9006	58,00	69,60	58,00	69,60	64,00	76,80
	026354		026378		026392	
PS 8 Prachovo šedá RAL 7037	58,00	69,60	58,00	69,60	64,00	76,80
	027405		027429		027443	
MM 9 Metalická medená RAL extra	58,00	69,60	58,00	69,60	64,00	76,80
	026804 *		026828		026842	
BHT – P.20 10 Bielo hliníková tmavá RAL 9007	58,00	69,60	58,00	69,60	64,00	76,80
	096210		096265		096319	
MZ 11 Machovo zelená RAL 6005	58,00	69,60	58,00	69,60	64,00	76,80
	027108 *		027122		027146 *	
MOT 12 Tmavo modrá RAL 5010	58,00	69,60	58,00	69,60	64,00	76,80
	026958 *		026972		027009 *	
TZ 13 Trávovo zelená RAL 6011	58,00	69,60	58,00	69,60	64,00	76,80
	027856 *		027870 *		027894 *	
Balenie v ks 	2		2		2	
Balenie v ks 	36		36		36	

* Výroba na objednávku



KOTLÍK ZBERNÝ DESING EXZENTRICKÝ

P-PKLZ DX



Menovitá veľkosť	80		100		120	
	Bez DPH	S DPH	Bez DPH	S DPH	Bez DPH	S DPH
TM 1 Testa di Moro RAL 8028	72,00	86,40	72,00	86,40	74,00	88,80
	027764		027795		027825	
AN 2 Antracit RAL 7016	72,00	86,40	72,00	86,40	74,00	88,80
	026262		026293		026323	
IC 3 Intenzívna čierna RAL 9005	72,00	86,40	72,00	86,40	74,00	88,80
	026569		026590		026620 *	
OC 4 Oceľovo červená RAL 3009	72,00	86,40	72,00	86,40	74,00	88,80
	027313		027344		027375 *	
MH 5 Medeno hnedá RAL 8004	72,00	86,40	72,00	86,40	74,00	88,80
	026712 *		026743 *		026774 *	
SB 6 Šedo biela RAL 9002	72,00	86,40	72,00	86,40	74,00	88,80
	027610 *		027641		027672	
BH 7 Bielo hliníková RAL 9006	72,00	86,40	72,00	86,40	74,00	88,80
	026415 *		026446		026477	
PS 8 Prachovo šedá RAL 7037	72,00	86,40	72,00	86,40	74,00	88,80
	027467 *		027498		027528	
MM 9 Metalická medená RAL extra	72,00	86,40	72,00	86,40	74,00	88,80
	026866 *		026897		026927 *	
BHT – P.20 10 Bielo hliníková tmavá RAL 9007	72,00	86,40	72,00	86,40	74,00	88,80
	096203 *		096258		096302	
MZ 11 Machovo zelená RAL 6005	72,00	86,40	72,00	86,40	74,00	88,80
	027160 *		027191 *		027221 *	
MOT 12 Tmavo modrá RAL 5010	72,00	86,40	72,00	86,40	74,00	88,80
	027016 *		027047 *		027078 *	
TZ 13 Trávovo zelená RAL 6011	72,00	86,40	72,00	86,40	74,00	88,80
	027917 *		027948 *		027979 *	
Balenie v ks 📦	2		2		2	
Balenie v ks 🚚	36		36		36	

* Výroba na objednávku

KOTLÍK ZBERNÝ KUBICKÝ

P-PKLZ KU



Menovitá veľkosť	80		100		120	
	Bez DPH	S DPH	Bez DPH	S DPH	Bez DPH	S DPH
TM 1 Testa di Moro RAL 8028	88,00	105,60	88,00	105,60	94,00	112,80
	027719 *		027733		027757	
AN 2 Antracit RAL 7016	88,00	105,60	88,00	105,60	94,00	112,80
	026217		026231		026255	
IC 3 Intenzívna čierna RAL 9005	88,00	105,60	88,00	105,60	94,00	112,80
	026514		026538		026552	
OC 4 Oceľovo červená RAL 3009	88,00	105,60	88,00	105,60	94,00	112,80
	027269 *		027283 *		027306	
MH 5 Medeno hnedá RAL 8004	88,00	105,60	88,00	105,60	94,00	112,80
	026668 *		026682 *		026705 *	
SB 6 Šedo biela RAL 9002	88,00	105,60	88,00	105,60	94,00	112,80
	027566 *		027580 *		027603 *	
BH 7 Bielo hliníková RAL 9006	88,00	105,60	88,00	105,60	94,00	112,80
	026361 *		026385		026408	
PS 8 Prachovo šedá RAL 7037	88,00	105,60	88,00	105,60	94,00	112,80
	027412 *		027436 *		027450	
MM 9 Metalická medená RAL extra	88,00	105,60	88,00	105,60	94,00	112,80
	026811 *		026835 *		026859 *	
BHT – P.20 10 Bielo hliníková tmavá RAL 9007	88,00	105,60	88,00	105,60	94,00	112,80
	096241 *		096296 *		096340 *	
MZ 11 Machovo zelená RAL 6005	88,00	105,60	88,00	105,60	94,00	112,80
	027115 *		027139 *		027153 *	
MOT 12 Tmavo modrá RAL 5010	88,00	105,60	88,00	105,60	94,00	112,80
	026965 *		026989 *		026996 *	
TZ 13 Trávovo zelená RAL 6011	88,00	105,60	88,00	105,60	94,00	112,80
	027863 *		027887 *		027900 *	
Balenie v ks 	2		2		2	
Balenie v ks 	36		36		36	

* Výroba na objednávku

KOTLÍK ZBERNÝ KUBICKÝ EXZENTRICKÝ

P-PKLZ KX





Menovitá veľkosť	80		100		120	
	Bez DPH	S DPH	Bez DPH	S DPH	Bez DPH	S DPH
TM 1 Testa di Moro RAL 8028	88,00	105,60	88,00	105,60	94,00	112,80
	027788		027818		027849	
AN 2 Antracit RAL 7016	88,00	105,60	88,00	105,60	94,00	112,80
	026286		026316		026347	
IC 3 Intenzívna čierna RAL 9005	88,00	105,60	88,00	105,60	94,00	112,80
	026583		026613		026644 *	
OC 4 Oceľovo červená RAL 3009	88,00	105,60	88,00	105,60	94,00	112,80
	027337 *		027368		027399	
MH 5 Medeno hnedá RAL 8004	88,00	105,60	88,00	105,60	94,00	112,80
	026736		026767		026798 *	
SB 6 Šedo biela RAL 9002	88,00	105,60	88,00	105,60	94,00	112,80
	027634 *		027665		027696	
BH 7 Bielo hliníková RAL 9006	88,00	105,60	88,00	105,60	94,00	112,80
	026439 *		026460		026491	
PS 8 Prachovo šedá RAL 7037	88,00	105,60	88,00	105,60	94,00	112,80
	027481 *		027511		027542	
MM 9 Metalická medená RAL extra	88,00	105,60	88,00	105,60	94,00	112,80
	026880 *		026910		026941 *	
BHT – P.20 10 Bielo hliníková tmavá RAL 9007	88,00	105,60	88,00	105,60	94,00	112,80
	096227		096272		096326	
MZ 11 Machovo zelená RAL 6005	88,00	105,60	88,00	105,60	94,00	112,80
	027184 *		027214		027245 *	
MOT 12 Tmavo modrá RAL 5010	88,00	105,60	88,00	105,60	94,00	112,80
	027030 *		027061 *		027092 *	
TZ 13 Trávovo zelená RAL 6011	88,00	105,60	88,00	105,60	94,00	112,80
	027931 *		027962		027993 *	
Balenie v ks 📦	2		2		2	
Balenie v ks 🚚	36		36		36	

* Výroba na objednávku

KOTLÍK ZBERNÝ KUBICKÝ EXZENTRICKÝ VÝTOK

P-PKLZ KXV





Menovitá veľkosť	80		100		120	
	Bez DPH	S DPH	Bez DPH	S DPH	Bez DPH	S DPH
TM 1 Testa di Moro RAL 8028	115,00	138,00	115,00	138,00	115,00	138,00
	027771 *		027801 *		027832 *	
AN 2 Antracit RAL 7016	115,00	138,00	115,00	138,00	115,00	138,00
	026279 *		026309 *		026330 *	
IC 3 Intenzívna čierna RAL 9005	115,00	138,00	115,00	138,00	115,00	138,00
	026576 *		026606		026637 *	
OC 4 Oceľovo červená RAL 3009	115,00	138,00	115,00	138,00	115,00	138,00
	027320 *		027351 *		027382 *	
MH 5 Medeno hnedá RAL 8004	115,00	138,00	115,00	138,00	115,00	138,00
	026729 *		026750 *		026781 *	
SB 6 Šedo biela RAL 9002	115,00	138,00	115,00	138,00	115,00	138,00
	027627 *		027658 *		027689 *	
BH 7 Bielo hliníková RAL 9006	115,00	138,00	115,00	138,00	115,00	138,00
	026422 *		026453 *		026484 *	
PS 8 Prachovo šedá RAL 7037	115,00	138,00	115,00	138,00	115,00	138,00
	027474 *		027504 *		027535 *	
MM 9 Metalická medená RAL extra	115,00	138,00	115,00	138,00	115,00	138,00
	026873 *		026903 *		026934 *	
BHT – P.20 10 Bielo hliníková tmavá RAL 9007	115,00	138,00	115,00	138,00	115,00	138,00
	096234 *		096289 *		096333 *	
MZ 11 Machovo zelená RAL 6005	115,00	138,00	115,00	138,00	115,00	138,00
	027177 *		027207 *		027238 *	
MOT 12 Tmavo modrá RAL 5010	115,00	138,00	115,00	138,00	115,00	138,00
	027023 *		027054 *		027085 *	
TZ 13 Trávovo zelená RAL 6011	115,00	138,00	115,00	138,00	115,00	138,00
	027924 *		027955 *		027986 *	
Balenie v ks 	2		2		2	
Balenie v ks 	36		36		36	

* Výroba na objednávku

EPDM TESNIACA GUMA ZBERNÉHO KOTLIČKA

P-PKLZ T



Menovitá veľkosť	EAN číslo výrobku	Balenie v ks		Cena [€/ks]	
				Bez DPH	S DPH
IC 70-85	077103	5	600	4,00	4,80
IC 100-110	077110	5	600	4,10	4,92
IC 110-125	077097	5	600	4,20	5,04
PS 70-85	077134	5	600	4,50	5,40
PS 100-110	077141	5	600	4,90	5,88
PS 110-125	077127	5	600	5,00	6,00

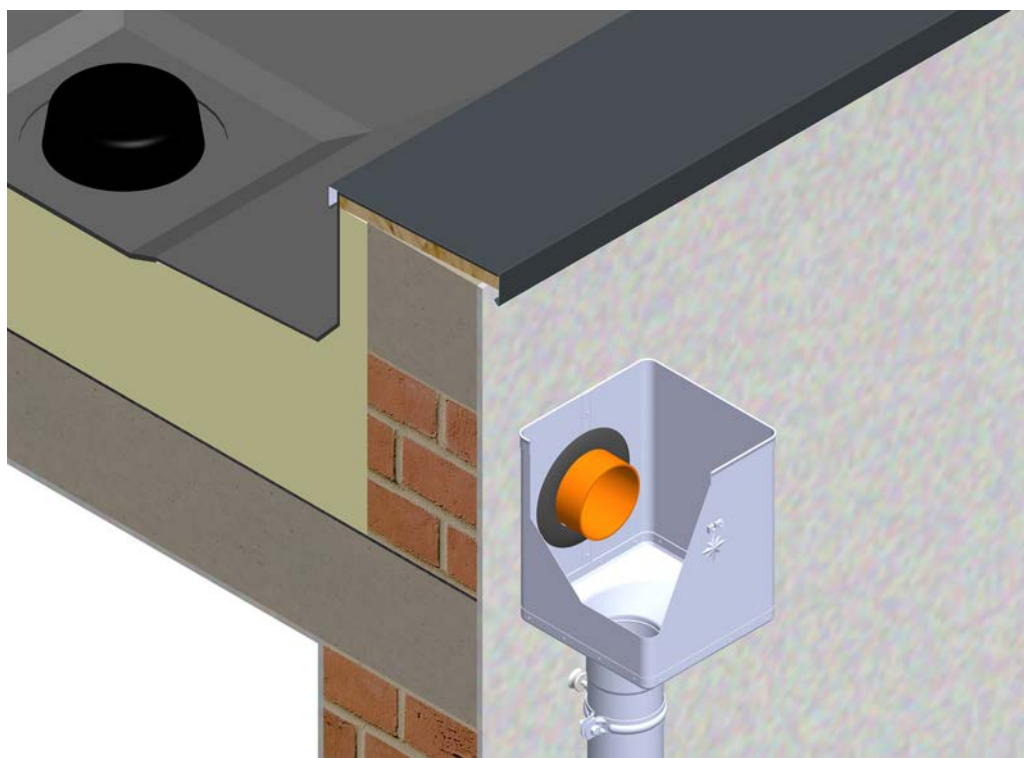

ZVODOVÉ KOLENO 72°

P-PK

Menovitá veľkosť	60		80		100		120		150	
	Bez DPH	S DPH	Bez DPH	S DPH	Bez DPH	S DPH	Bez DPH	S DPH	Bez DPH	S DPH
TM 1 Testa di Moro RAL 8028	6,00	7,20	5,50	6,60	6,00	7,20	8,50	10,20	19,95	23,94
	072542		072559		072573		072597		033697	
AN 2 Antracit RAL 7016	6,00	7,20	5,50	6,60	6,00	7,20	8,50	10,20	19,95	23,94
	071842		071859		071873		071897		033598	
IC 3 Intenzívna čierna RAL 9005	6,00	7,20	5,50	6,60	6,00	7,20	8,50	10,20	19,95	23,94
	071989		072023		072009		072030		033611	
OC 4 Oceľovo červená RAL 3009	6,00	7,20	5,50	6,60	6,00	7,20	8,50	10,20	19,95	23,94
	072337		072344		072368		072382		033666	
MH 5 Medeno hnedá RAL 8004	6,00	7,20	5,50	6,60	6,00	7,20	8,50	10,20	19,95	23,94
	072054		072061		072085		072108		033628	
SB 6 Šedo biela RAL 9002	6,00	7,20	5,50	6,60	6,00	7,20	8,50	10,20	19,95	23,94
	072474		072481		072504		072528		033680	
BH 7 Bielo hliníková RAL 9006	6,00	7,20	5,50	6,60	6,00	7,20	8,50	10,20	19,95	23,94
	071910		071927		071941		071965		033604	
PS 8 Prachovo šedá RAL 7037	6,00	7,20	5,50	6,60	6,00	7,20	8,50	10,20	19,95	23,94
	072405		072412		072429		072443		033673	
MM 9 Metalická medená RAL extra	6,00	7,20	5,50	6,60	6,00	7,20	8,50	10,20	19,95	23,94
	072122		072139		072153		072160		033635	
BHT – P.20 10 Bielo hliníková tmavá RAL 9007	6,00	7,20	5,50	6,60	6,00	7,20	8,50	10,20	19,95	23,94
	118691 *		095183		095206		095220		095244	
MZ 11 Machovo zelená RAL 6005	6,00	7,20	5,50	6,60	6,00	7,20	8,50	10,20	19,95	23,94
	072269		072276		072290		072313		033659	
MOT 12 Tmavo modrá RAL 5010	6,00	7,20	5,50	6,60	6,00	7,20	8,50	10,20	19,95	23,94
	072191		072207		072221		072245		033642	
TZ 13 Trávovo zelená RAL 6011	6,00	7,20	5,50	6,60	6,00	7,20	8,50	10,20	19,95	23,94
	072610 *		072627		072641		072665		033703 *	
Balenie v ks 📦	25		25		25		15		5	
Balenie v ks 🚚	600		400		300		180		90	

* Výroba na objednávku



ZVODOVÉ KOLENO RÁDIUS 85°

P-PKR



Menovitá veľkosť	80		100		120	
	Bez DPH	S DPH	Bez DPH	S DPH	Bez DPH	S DPH
TM 1 Testa di Moro RAL 8028	6,90	8,28	7,80	9,36	12,40	14,88
	072566		072580		072603	
AN 2 Antracit RAL 7016	6,90	8,28	7,80	9,36	12,40	14,88
	071866		071880		071903	
IC 3 Intenzívna čierna RAL 9005	6,90	8,28	7,80	9,36	12,40	14,88
	071996		072016		072047	
OC 4 Oceľovo červená RAL 3009	6,90	8,28	7,80	9,36	12,40	14,88
	072351		072375		072399	
MH 5 Medeno hnedá RAL 8004	6,90	8,28	7,80	9,36	12,40	14,88
	072078		072092		072115	
SB 6 Šedo biela RAL 9002	6,90	8,28	7,80	9,36	12,40	14,88
	072498		072511		072535	
BH 7 Bielo hliníková RAL 9006	6,90	8,28	7,80	9,36	12,40	14,88
	071934		071958		071972	
PS 8 Prachovo šedá RAL 7037	6,90	8,28	7,80	9,36	12,40	14,88
	072467		072436		072450	
MM 9 Metalická medená RAL extra	6,90	8,28	7,80	9,36	12,40	14,88
	072146		072184		072177	
BHT – P.20 10 Bielo hliníková tmavá RAL 9007	6,90	8,28	7,80	9,36	12,40	14,88
	095190		095213		095237 *	
MZ 11 Machovo zelená RAL 6005	6,90	8,28	7,80	9,36	12,40	14,88
	072283		072306		072320	
MOT 12 Tmavo modrá RAL 5010	6,90	8,28	7,80	9,36	12,40	14,88
	072214 *		072238 *		072252 *	
TZ 13 Trávovo zelená RAL 6011	6,90	8,28	7,80	9,36	12,40	14,88
	072634 *		072658 *		072672 *	
Balenie v ks 	25		25		15	
Balenie v ks 	400		300		180	

* Výroba na objednávku



ZVODOVÉ KOLENO TUPÉ 40°

P-PKT

Menovitá veľkosť	80		100		120	
	Bez DPH	S DPH	Bez DPH	S DPH	Bez DPH	S DPH
TM 1 Testa di Moro RAL 8028	6,50	7,80	7,10	8,52	10,00	12,00
	072993		073006		073013	
AN 2 Antracit RAL 7016	6,50	7,80	7,10	8,52	10,00	12,00
	072696		072702		072719	
IC 3 Intenzívna čierna RAL 9005	6,50	7,80	7,10	8,52	10,00	12,00
	072757		072764		072771	
OC 4 Oceľovo červená RAL 3009	6,50	7,80	7,10	8,52	10,00	12,00
	072900		072917		072924	
MH 5 Medeno hnedá RAL 8004	6,50	7,80	7,10	8,52	10,00	12,00
	072795		072788		072801	
SB 6 Šedo biela RAL 9002	6,50	7,80	7,10	8,52	10,00	12,00
	072962		072979		072986	
BH 7 Bielo hliníková RAL 9006	6,50	7,80	7,10	8,52	10,00	12,00
	072726		072733		072740	
PS 8 Prachovo šedá RAL 7037	6,50	7,80	7,10	8,52	10,00	12,00
	072931		072948		072955	
MM 9 Metalická medená RAL extra	6,50	7,80	7,10	8,52	10,00	12,00
	072818		072825		072832 *	
BHT – P.20 10 Bielo hliníková tmavá RAL 9007	6,50	7,80	7,10	8,52	10,00	12,00
	094711		094728		094735	
MZ 11 Machovo zelená RAL 6005	6,50	7,80	7,10	8,52	10,00	12,00
	072870 *		072887		072894	
MOT 12 Tmavo modrá RAL 5010	6,50	7,80	7,10	8,52	10,00	12,00
	072849		072856		072863	
TZ 13 Trávovo zelená RAL 6011	6,50	7,80	7,10	8,52	10,00	12,00
	073020 *		073037 *		073044 *	
Balenie v ks 	25		25		15	
Balenie v ks 	400		300		240	

* Výroba na objednávku



KOLENO VÝTOKOVÉ ZIGNA 72°

P-PKV



Menovitá veľkosť	80		100		120	
	Bez DPH	S DPH	Bez DPH	S DPH	Bez DPH	S DPH
TM 1 Testa di Moro RAL 8028	6,50	7,80	7,00	8,40	9,50	11,40
	095046		095053		095060	
AN 2 Antracit RAL 7016	6,50	7,80	7,00	8,40	9,50	11,40
	094742		094759		094766	
IC 3 Intenzívna čierna RAL 9005	6,50	7,80	7,00	8,40	9,50	11,40
	094803		094810		094827 *	
OC 4 Oceľovo červená RAL 3009	6,50	7,80	7,00	8,40	9,50	11,40
	094957 *		094964		094971 *	
MH 5 Medeno hnedá RAL 8004	6,50	7,80	7,00	8,40	9,50	11,40
	094834		094841		094858	
SB 6 Šedo biela RAL 9002	6,50	7,80	7,00	8,40	9,50	11,40
	095015 *		095022		095039	
BH 7 Bielo hliníková RAL 9006	6,50	7,80	7,00	8,40	9,50	11,40
	094773 *		094780		094797	
PS 8 Prachovo šedá RAL 7037	6,50	7,80	7,00	8,40	9,50	11,40
	094988 *		094995 *		095008 *	
MM 9 Metalická medená RAL extra	6,50	7,80	7,00	8,40	9,50	11,40
	094865 *		094872 *		094889 *	
BHT – P.20 10 Bielo hliníková tmavá RAL 9007	6,50	7,80	7,00	8,40	9,50	11,40
	124739 *		124746 *		124753 *	
MZ 11 Machovo zelená RAL 6005	6,50	7,80	7,00	8,40	9,50	11,40
	094926 *		094933 *		094940 *	
MOT 12 Tmavo modrá RAL 5010	6,50	7,80	7,00	8,40	9,50	11,40
	094896 *		094902 *		094919 *	
TZ 13 Trávovo zelená RAL 6011	6,50	7,80	7,00	8,40	9,50	11,40
	095077 *		095084 *		095091 *	
Balenie v ks 📦	25		25		15	
Balenie v ks 🚚	400		300		180	

* Výroba na objednávku

ZVODOVÉ KOLENO FALCOVANÉ 72°

P-PKF2



Menovitá veľkosť	60		80		100		120	
Cena v €/ks	Bez DPH	S DPH	Bez DPH	S DPH	Bez DPH	S DPH	Bez DPH	S DPH
TM 1 Testa di Moro RAL 8028	4,30	5,16	3,40	4,08	4,40	5,28	6,30	7,56
	071781		071798		071811		071828	
Balenie v ks	10		10		10		8	
Balenie v ks	3 000		1 200		1 000		576	

ZVODOVÉ KOLENO FALCOVANÉ 85°

P-PKF3



Menovitá veľkosť	80		100	
Cena v €/ks	Bez DPH	S DPH	Bez DPH	S DPH
TM 1 Testa di Moro RAL 8028	4,40	5,28	6,30	7,56
	071804		071835	
Balenie v ks	10		10	
Balenie v ks	1 200		800	

PLASTOVÝ ZVODOVÝ RUKÁV

SD-ZR FOLIA KJG



Menovitá veľkosť	Dĺžka v m	EAN číslo výrobku	Balenie v m		Cena [€/ks]	
					Bez DPH	S DPH
60 – 150	100,0	139726	100	6 000	0,38	0,46

ZVODOVÁ RÚRA [s=0,55]

P-PZR



Menovitá veľkosť	60		60		80		80		80	
	2,0		3,0		1,0		2,0		3,0	
Dĺžka v m	2,0		3,0		1,0		2,0		3,0	
	Bez DPH	S DPH	Bez DPH	S DPH	Bez DPH	S DPH	Bez DPH	S DPH	Bez DPH	S DPH
TM Testa di Moro RAL 8028	7,20	8,64	7,20	8,64	7,20	8,64	7,20	8,64	7,00	8,40
	071309		071316		071323		071330		071347	
AN Antracit RAL 7016	7,20	8,64	7,20	8,64	7,20	8,64	7,20	8,64	7,00	8,40
	069467		069474		069481		069498		069504	
IC Intenzívna čierna RAL 9005	7,20	8,64	7,20	8,64	7,20	8,64	7,20	8,64	7,00	8,40
	069900		069917		069924		069931		069948	
OC Oceľovo červená RAL 3009	7,20	8,64	7,20	8,64	7,20	8,64	7,20	8,64	7,00	8,40
	070661		070678		070685		070692		070708	
MH Medeno hnedá RAL 8004	8,10	9,72			7,30	8,76	7,30	8,76	7,10	8,52
	070128				070142		070159		070166	
SB Šedo biela RAL 9002	8,10	9,72	8,10	9,72	7,30	8,76	7,30	8,76	7,10	8,52
	071088		071095		071101		071118		071125	
BH Bielo hliníková RAL 9006	8,10	9,72	8,10	9,72	7,30	8,76	7,30	8,76	7,10	8,52
	069689		069696		069702		069719		069726	
PS Prachovo šedá RAL 7037	8,10	9,72	8,10	9,72	7,30	8,76	7,30	8,76	7,10	8,52
	070883		070890		070906		070913		070920	
MM Metalická medená RAL extra	8,50	10,20			7,75	9,30	7,75	9,30	7,55	9,06
	070340				070364		070371		070388	
BHT – P.20 Bielo hliníková tmavá RAL 9007									8,55	10,26
									096128	
MZ Machovo zelená RAL 6005	8,50	10,20							7,55	9,06
	070586								070593	
MOT Tmavo modrá RAL 5010	8,50	10,20							7,55	9,06
	070494								070500	
TZ Trávovo zelená RAL 6011	8,50	10,20					7,75	9,30		
	071521 *						071538			
Balenie v m 📦	10		15		10		10		15	
Balenie v m 🚚	490		735		100		250		375	

* Výroba na objednávku

ZVODOVÁ RÚRA [s=0,55]
P-PZR

Menovitá veľkosť	80		80		80		100		100	
	4,0		5,0		6,0		1,0		2,0	
Dĺžka v m	4,0		5,0		6,0		1,0		2,0	
Cena v €/m	Bez DPH	S DPH	Bez DPH	S DPH	Bez DPH	S DPH	Bez DPH	S DPH	Bez DPH	S DPH
	TM 1 Testa di Moro RAL 8028	7,00	8,40	7,00	8,40	7,00	8,40	7,40	8,88	7,40
071354		071361 *		071378 *		071385		071392		
AN 2 Antracit RAL 7016	7,00	8,40	7,00	8,40	7,00	8,40	7,40	8,88	7,40	8,88
	069511		069528 *		069535 *		069542		069559	
IC 3 Intenzívna čierna RAL 9005	7,00	8,40	7,00	8,40	7,00	8,40	7,40	8,88	7,40	8,88
	069955		069962 *		069979 *		069986		069993	
OC 4 Oceľovo červená RAL 3009	7,00	8,40	7,00	8,40	7,00	8,40	7,40	8,88	7,40	8,88
	070715		070722 *		070739 *		070746		070753	
MH 5 Medeno hnedá RAL 8004	7,10	8,52	7,10	8,52	7,10	8,52	7,50	9,00	7,50	9,00
	070173		070180 *		070197 *		070203		070210	
SB 6 Šedo biela RAL 9002	7,10	8,52	7,10	8,52	7,10	8,52	7,50	9,00	7,50	9,00
	071132		071149 *		071156 *		071163		071170	
BH 7 Bielo hliníková RAL 9006	7,10	8,52	7,10	8,52	7,10	8,52	7,50	9,00	7,50	9,00
	069733		069740 *		069757 *		069764		069771	
PS 8 Prachovo šedá RAL 7037	7,10	8,52	7,10	8,52	7,10	8,52	7,50	9,00	7,50	9,00
	070937		070944 *		070951 *		070968		070975	
MM 9 Metalická medená RAL extra	7,55	9,06					8,40	10,08	8,40	10,08
	070395						070401		070418	
BHT – P.20 10 Bielo hliníková tmavá RAL 9007										
MZ 11 Machovo zelená RAL 6005	7,55	9,06								
	070609									
MOT 12 Tmavo modrá RAL 5010										
TZ 13 Trávovo zelená RAL 6011										
Balenie v m	20		5		6		10		10	
Balenie v m	500		625		750		70		160	

* Výroba na objednávku



ZVODOVÁ RÚRA [s=0,55]

P-PZR



Menovitá veľkosť	100		100		100		100		120	
	3,0		4,0		5,0		6,0		1,0	
Dĺžka v m	3,0		4,0		5,0		6,0		1,0	
Cena v €/m	Bez DPH	S DPH	Bez DPH	S DPH	Bez DPH	S DPH	Bez DPH	S DPH	Bez DPH	S DPH
TM 1 Testa di Moro RAL 8028	7,20	8,64	7,20	8,64	7,20	8,64	7,20	8,64	10,75	12,90
	071408		071415		071422		071439 *		071446	
AN 2 Antracit RAL 7016	7,20	8,64	7,20	8,64	7,20	8,64	7,20	8,64	10,75	12,90
	069566		069573		069580		069597 *		069603	
IC 3 Intenzívna čierna RAL 9005	7,20	8,64	7,20	8,64	7,20	8,64	7,20	8,64	10,75	12,90
	070005		070012		070029		070036 *		070043	
OC 4 Oceľovo červená RAL 3009	7,20	8,64	7,20	8,64	7,20	8,64	7,20	8,64	10,75	12,90
	070760		070777		070784 *		070791 *		070807	
MH 5 Medeno hnedá RAL 8004	7,30	8,76	7,30	8,76	7,30	8,76	7,30	8,76	10,85	13,02
	070227		070234		070241 *		070258 *		070265	
SB 6 Šedo biela RAL 9002	7,30	8,76	7,30	8,76	7,30	8,76	7,30	8,76	10,85	13,02
	071187		071194		071200 *		071217 *		071224	
BH 7 Bielo hliníková RAL 9006	7,30	8,76	7,30	8,76	7,30	8,76	7,30	8,76	10,85	13,02
	069788		069795		069801 *		069818 *		069825	
PS 8 Prachovo šedá RAL 7037	7,30	8,76	7,30	8,76	7,30	8,76	7,30	8,76	10,85	13,02
	070982		070999		071002 *		071019 *		071026	
MM 9 Metalická medená RAL extra	8,20	9,84	8,20	9,84					11,50	13,80
	070425		070432						070449	
BHT – P.20 10 Bielo hliníková tmavá RAL 9007	8,80	10,56	8,80	10,56						
	096135		096142							
MZ 11 Machovo zelená RAL 6005	8,20	9,84	8,20	9,84						
	070616		070623							
MOT 12 Tmavo modrá RAL 5010	8,20	9,84	8,20	9,84						
	070524		070531							
TZ 13 Trávovo zelená RAL 6011	8,20	9,84	8,20	9,84						
	071545		071552							
Balenie v m 📦	15		20		5		6		8	
Balenie v m 🚚	240		320		400		480		48	

* Výroba na objednávku

ZVODOVÁ RÚRA [s=0,55]
P-PZR

Menovitá veľkosť	120		120		120		120		120	
	2,0		3,0		4,0		5,0		6,0	
Dĺžka v m	2,0		3,0		4,0		5,0		6,0	
Cena v €/m	Bez DPH	S DPH	Bez DPH	S DPH	Bez DPH	S DPH	Bez DPH	S DPH	Bez DPH	S DPH
TM Testa di Moro RAL 8028	10,75	12,90	10,55	12,66	10,55	12,66	10,55	12,66	10,55	12,66
	071453		071460		071477		071484 *		071491 *	
AN Antracit RAL 7016	10,75	12,90	10,55	12,66	10,55	12,66	10,55	12,66	10,55	12,66
	069610		069627		069634		069641 *		069658 *	
IC Intenzívna čierna RAL 9005	10,75	12,90	10,55	12,66	10,55	12,66	10,55	12,66	10,55	12,66
	070050		070067		070074		070081 *		070098 *	
OC Oceľovo červená RAL 3009	10,75	12,90	10,55	12,66	10,55	12,66	10,55	12,66	10,55	12,66
	070814		070821		070838		070845 *		070852 *	
MH Medeno hnedá RAL 8004	10,85	13,02	10,65	12,78	10,65	12,78	10,65	12,78	10,65	12,78
	070272		070289		070296		070302 *		070319 *	
SB Šedo biela RAL 9002	10,85	13,02	10,65	12,78	10,65	12,78	10,65	12,78	10,65	12,78
	071231		071248		071255		071262		071279 *	
BH Bielo hliníková RAL 9006	10,85	13,02	10,65	12,78	10,65	12,78	10,65	12,78	10,65	12,78
	069832		069849		069856		069863		069870 *	
PS Prachovo šedá RAL 7037	10,85	13,02	10,65	12,78	10,65	12,78				
	071033		071040		071057					
MM Metalická medená RAL extra	11,50	13,80	11,35	13,62	11,35	13,62				
	070456		070463		070470					
BHT – P.20 Bielo hliníková tmavá RAL 9007			12,05	14,46						
			096159							
MZ Machovo zelená RAL 6005			11,35	13,62	11,35	13,62				
			070630		070647					
MOT Tmavo modrá RAL 5010			11,35	13,62	11,35	13,62				
			070548		070555					
TZ Trávovo zelená RAL 6011			11,35	13,62	11,35	13,62				
			071569		071576					
Balenie v m 📦	10		15		20		5		6	
Balenie v m 🚚	120		180		240		300		360	

* Výroba na objednávku





ZVODOVÁ RÚRA [s=0,55]
P-PZR

Menovitá veľkosť	150		150	
	3,0		4,0	
Dĺžka v m	3,0		4,0	
Cena v €/m	Bez DPH	S DPH	Bez DPH	S DPH
TM 1 Testa di Moro RAL 8028	20,60	24,72	20,60	24,72
	071507		071514	
AN 2 Antracit RAL 7016	20,60	24,72	20,60	24,72
	069665		069672	
IC 3 Intenzívna čierna RAL 9005			20,60	24,72
			070111	
OC 4 Oceľovo červená RAL 3009			20,60	24,72
			070876	
MH 5 Medeno hnedá RAL 8004	20,70	24,84		
	070326			
SB 6 Šedo biela RAL 9002	20,70	24,84	20,70	24,84
	071286		071293	
BH 7 Bielo hliníková RAL 9006	20,70	24,84	20,70	24,84
	069887		069894	
PS 8 Prachovo šedá RAL 7037	20,70	24,84	20,70	24,84
	071064		071071	
MM 9 Metalická medená RAL extra	21,80	26,16		
	070487			
BHT – P.20 10 Bielo hliníková tmavá RAL 9007	22,25	26,70		
	096166			
MZ 11 Machovo zelená RAL 6005	21,80	26,16		
	070654			
MOT 12 Tmavo modrá RAL 5010			21,80	26,16
			070579	
TZ 13 Trávovo zelená RAL 6011	21,80	26,16		
	071583 *			
Balenie v m 📦	3		4	
Balenie v m 🚚	84		112	

* Výroba na objednávku

SPOJKA ZVODOVEJ RÚRY

P-PSRU

Menovitá veľkosť	80		100		120	
	Bez DPH	S DPH	Bez DPH	S DPH	Bez DPH	S DPH
TM 1 Testa di Moro RAL 8028	4,25	5,10	4,40	5,28	4,90	5,88
	017581		017598		017604	
AN 2 Antracit RAL 7016	4,25	5,10	4,40	5,28	4,90	5,88
	017284		017291		017307	
IC 3 Intenzívna čierna RAL 9005	4,25	5,10	4,40	5,28	4,90	5,88
	017345		017352		017369	
OC 4 Oceľovo červená RAL 3009	4,25	5,10	4,40	5,28	4,90	5,88
	017499		017505		017512	
MH 5 Medeno hnedá RAL 8004	4,25	5,10	4,40	5,28	4,90	5,88
	017376		017383		017390	
SB 6 Šedo biela RAL 9002	4,25	5,10	4,40	5,28	4,90	5,88
	017550		017567		017574	
BH 7 Bielo hliníková RAL 9006	4,25	5,10	4,40	5,28	4,90	5,88
	017314		017321		017338	
PS 8 Prachovo šedá RAL 7037	4,25	5,10	4,40	5,28	4,90	5,88
	017529		017536		017543	
MM 9 Metalická medená RAL extra	4,25	5,10	4,40	5,28	4,90	5,88
	017406		017413		017420	
BHT – P.20 10 Bielo hliníková tmavá RAL 9007	4,25	5,10	4,40	5,28	4,90	5,88
	095657 *		095664		095671 *	
MZ 11 Machovo zelená RAL 6005	4,25	5,10	4,40	5,28	4,90	5,88
	017468 *		017475		017482	
MOT 12 Tmavo modrá RAL 5010	4,25	5,10	4,40	5,28	4,90	5,88
	017437 *		017444		017451	
TZ 13 Trávovo zelená RAL 6011	4,25	5,10	4,40	5,28	4,90	5,88
	017611 *		017628		017635 *	
Balenie v ks 	10		10		8	
Balenie v ks 	900		900		720	

* Výroba na objednávku



ZVODOVÉ KOLENO ODSKOKOVÉ

P-PKO



Menovitá veľkosť	80		100		120	
	Bez DPH	S DPH	Bez DPH	S DPH	Bez DPH	S DPH
TM 1 Testa di Moro RAL 8028	9,40	11,28	9,70	11,64	13,95	16,74
	034045		034052		034069	
AN 2 Antracit RAL 7016	9,40	11,28	9,70	11,64	13,95	16,74
	033741		033758		033765	
IC 3 Intenzívna čierna RAL 9005	9,40	11,28	9,70	11,64	13,95	16,74
	033802		033819		033826	
OC 4 Oceľovo červená RAL 3009	9,40	11,28	9,70	11,64	13,95	16,74
	033956		033963		033970	
MH 5 Medeno hnedá RAL 8004	9,40	11,28	9,70	11,64	13,95	16,74
	033833		033840		033857	
SB 6 Šedo biela RAL 9002	9,40	11,28	9,70	11,64	13,95	16,74
	034014		034021		034038	
BH 7 Bielo hliníková RAL 9006	9,40	11,28	9,70	11,64	13,95	16,74
	033772		033789		033796	
PS 8 Prachovo šedá RAL 7037	9,40	11,28	9,70	11,64	13,95	16,74
	033987		033994		034007	
MM 9 Metalická medená RAL extra	9,40	11,28	9,70	11,64	13,95	16,74
	033864		033871		033888	
BHT – P.20 10 Bielo hliníková tmavá RAL 9007	9,40	11,28	9,70	11,64	13,95	16,74
	095688		095695		095701	
MZ 11 Machovo zelená RAL 6005	9,40	11,28	9,70	11,64	13,95	16,74
	033925		033932		033949	
MOT 12 Tmavo modrá RAL 5010	9,40	11,28	9,70	11,64	13,95	16,74
	033895		033901		033918	
TZ 13 Trávovo zelená RAL 6011	9,40	11,28	9,70	11,64	13,95	16,74
	034076		034083		034090	
Balenie v ks	20		20		15	
Balenie v ks	320		240		180	

ZVODOVÁ ODBOČKA 72°

P-PZO

Menovitá veľkosť	80/80		100/60		100/80		100/100	
	Bez DPH	S DPH	Bez DPH	S DPH	Bez DPH	S DPH	Bez DPH	S DPH
TM 1 Testa di Moro RAL 8028	15,65	18,78	17,40	20,88	17,40	20,88	18,00	21,60
	016157		016164		016171		016188	
AN 2 Antracit RAL 7016	15,65	18,78	17,40	20,88	17,40	20,88	18,00	21,60
	015259		015266		015273		015280	
IC 3 Intenzívna čierna RAL 9005	15,65	18,78	17,40	20,88	17,40	20,88	18,00	21,60
	015433		015440		015457		015464	
OC 4 Oceľovo červená RAL 3009	15,65	18,78	17,40	20,88	17,40	20,88	18,00	21,60
	015884		015891		015907		015914	
MH 5 Medeno hnedá RAL 8004	15,65	18,78	17,40	20,88	17,40	20,88	18,00	21,60
	015525		015532 *		015549		015556	
SB 6 Šedo biela RAL 9002	15,65	18,78	17,40	20,88	17,40	20,88	18,00	21,60
	016065		016072 *		016089		016096	
BH 7 Bielo hliníková RAL 9006	15,65	18,78	17,40	20,88	17,40	20,88	18,00	21,60
	015341		015358 *		015365		015372	
PS 8 Prachovo šedá RAL 7037	15,65	18,78	17,40	20,88	17,40	20,88	18,00	21,60
	015976 *		015983 *		015990		016003	
MM 9 Metalická medená RAL extra	15,65	18,78	17,40	20,88	17,40	20,88	18,00	21,60
	015617		015624 *		015631		015648	
BHT – P.20 10 Bielo hliníková tmavá RAL 9007	15,65	18,78			17,40	20,88	18,00	21,60
	096005 *				096012 *		096029 *	
MZ 11 Machovo zelená RAL 6005	15,65	18,78	17,40	20,88	17,40	20,88	18,00	21,60
	015792		015808 *		015815		015822	
MOT 12 Tmavo modrá RAL 5010	15,65	18,78	17,40	20,88	17,40	20,88	18,00	21,60
	015709 *		015716 *		015723 *		015730	
TZ 13 Trávovo zelená RAL 6011	15,65	18,78	17,40	20,88	17,40	20,88	18,00	21,60
	016249 *		016256 *		016263 *		016270 *	
Balenie v ks 	4		4		4		4	
Balenie v ks 	120		120		120		120	

* Výroba na objednávku



ZVODOVÁ ODBOČKA 72°

P-PZO



Menovitá veľkosť	120/80		120/100		120/120		150/120		150/150	
	Bez DPH	S DPH	Bez DPH	S DPH	Bez DPH	S DPH	Bez DPH	S DPH	Bez DPH	S DPH
TM 1 Testa di Moro RAL 8028	19,80	23,76	19,80	23,76	19,80	23,76	28,80	34,56	28,80	34,56
	016195		016201		016218		016225 *		016232 *	
AN 2 Antracit RAL 7016	19,80	23,76	19,80	23,76	19,80	23,76	28,80	34,56	28,80	34,56
	015297		015303		015310		015327 *		015334 *	
IC 3 Intenzívna čierna RAL 9005	19,80	23,76	19,80	23,76	19,80	23,76	28,80	34,56	28,80	34,56
	015471		015488		015495		015501 *		015518 *	
OC 4 Oceľovo červená RAL 3009	19,80	23,76	19,80	23,76	19,80	23,76	28,80	34,56	28,80	34,56
	015921		015938		015945		015952 *		015969 *	
MH 5 Medeno hnedá RAL 8004	19,80	23,76	19,80	23,76	19,80	23,76	28,80	34,56	28,80	34,56
	015563		015570		015587		015594 *		015600 *	
SB 6 Šedo biela RAL 9002	19,80	23,76	19,80	23,76	19,80	23,76	28,80	34,56	28,80	34,56
	016102		016119		016126		016133 *		016140 *	
BH 7 Bielo hliníková RAL 9006	19,80	23,76	19,80	23,76	19,80	23,76	28,80	34,56	28,80	34,56
	015389		015396		015402		015419 *		015426 *	
PS 8 Prachovo šedá RAL 7037	19,80	23,76	19,80	23,76	19,80	23,76	28,80	34,56	28,80	34,56
	016010 *		016027		016034		016041 *		016058 *	
MM 9 Metalická medená RAL extra	19,80	23,76	19,80	23,76	19,80	23,76	28,80	34,56	28,80	34,56
	015655 *		015662		015679		015686 *		015693 *	
BHT – P.20 10 Bielo hliníková tmavá RAL 9007	19,80	23,76	19,80	23,76	19,80	23,76				
	096036 *		096043 *		096050 *					
MZ 11 Machovo zelená RAL 6005	19,80	23,76	19,80	23,76	19,80	23,76	28,80	34,56	28,80	34,56
	015839 *		015846 *		015853 *		015860 *		015877 *	
MOT 12 Tmavo modrá RAL 5010	19,80	23,76	19,80	23,76	19,80	23,76	28,80	34,56	28,80	34,56
	015747 *		015754 *		015761 *		015778 *		015785 *	
TZ 13 Trávovo zelená RAL 6011	19,80	23,76	19,80	23,76	19,80	23,76	28,80	34,56	28,80	34,56
	016287 *		016294 *		016300 *		016317 *		016324 *	
Balenie v ks 📦	3		3		3		2		2	
Balenie v ks 🚚	90		90		90		36		36	

* Výroba na objednávku

ZVODOVÝ ROZDELOVAČ VODY

P-PRV



Menovitá veľkosť	80		100		120	
	Bez DPH	S DPH	Bez DPH	S DPH	Bez DPH	S DPH
TM 1 Testa di Moro RAL 8028	195,00	234,00	199,90	239,88	259,00	310,80
	088413 *		088420		088437 *	
AN 2 Antracit RAL 7016	195,00	234,00	199,90	239,88	259,00	310,80
	088116 *		088123		088130 *	
IC 3 Intenzívna čierna RAL 9005	195,00	234,00	199,90	239,88	259,00	310,80
	088178 *		088185 *		088192 *	
OC 4 Oceľovo červená RAL 3009	195,00	234,00	199,90	239,88	259,00	310,80
	088321 *		088338 *		088345 *	
MH 5 Medeno hnedá RAL 8004	195,00	234,00	199,90	239,88	259,00	310,80
	088208 *		088215 *		088222 *	
SB 6 Šedo biela RAL 9002	195,00	234,00	199,90	239,88	259,00	310,80
	088383 *		088390 *		088406 *	
BH 7 Bielo hliníková RAL 9006	195,00	234,00	199,90	239,88	259,00	310,80
	088147 *		088154 *		088161 *	
PS 8 Prachovo šedá RAL 7037	195,00	234,00	199,90	239,88	259,00	310,80
	088352 *		088369 *		088376 *	
MM 9 Metalická medená RAL extra	195,00	234,00	199,90	239,88	259,00	310,80
	088239 *		088246 *		088253 *	
BHT – P.20 10 Bielo hliníková tmavá RAL 9007	195,00	234,00	199,90	239,88	259,00	310,80
	095756 *		095763 *		095770 *	
MZ 11 Machovo zelená RAL 6005	195,00	234,00	199,90	239,88	259,00	310,80
	088291 *		088307 *		088314 *	
MOT 12 Tmavo modrá RAL 5010	195,00	234,00	199,90	239,88	259,00	310,80
	088260 *		088277 *		088284 *	
TZ 13 Trávovo zelená RAL 6011	195,00	234,00	199,90	239,88	259,00	310,80
	088444 *		088451 *		088468 *	
Balenie v ks	1		1		1	
Balenie v ks	-		-		-	

* Výroba na objednávku

ZVODOVÁ OBJÍMKA S HROTOM 150 mm

P-PO

Menovitá veľkosť	80		100		120	
	Bez DPH	S DPH	Bez DPH	S DPH	Bez DPH	S DPH
TM 1 Testa di Moro RAL 8028	3,30	3,96	3,35	4,02	4,00	4,80
	002136		002143		002150	
AN 2 Antracit RAL 7016	3,30	3,96	3,35	4,02	4,00	4,80
	001986		001993		002006	
IC 3 Intenzívna čierna RAL 9005	3,30	3,96	3,35	4,02	4,00	4,80
	002013		002020		002037	
OC 4 Oceľovo červená RAL 3009	3,30	3,96	3,35	4,02	4,00	4,80
	002075		002082		002099	
MH 5 Medeno hnedá RAL 8004	3,30	3,96	3,35	4,02	4,00	4,80
	002044		002051		002068	
SB 6 Šedo biela RAL 9002	3,30	3,96	3,35	4,02	4,00	4,80
	002105		002112		002129	
Balenie v ks 📦	25		25		25	
Balenie v ks 🚚	1 000		1 000		1 000	



ZVODOVÁ OBJÍMKA S HROTOM 200 mm



P-POD

Menovitá veľkosť	80		100		120	
	Bez DPH	S DPH	Bez DPH	S DPH	Bez DPH	S DPH
TM 1 Testa di Moro RAL 8028	3,50	4,20	3,50	4,20	4,05	4,86
	001955		001962		001979	
AN 2 Antracit RAL 7016	3,50	4,20	3,50	4,20	4,05	4,86
	001801		001818		001825	
IC 3 Intenzívna čierna RAL 9005	3,50	4,20	3,50	4,20	4,05	4,86
	001832		001849		001856	
OC 4 Oceľovo červená RAL 3009	3,50	4,20	3,50	4,20	4,05	4,86
	001894		001900		001917	
MH 5 Medeno hnedá RAL 8004	3,50	4,20	3,50	4,20	4,05	4,86
	001863		001870		001887	
SB 6 Šedo biela RAL 9002	3,50	4,20	3,50	4,20	4,05	4,86
	001924		001931		001948	
Balenie v ks 📦	25		25		25	
Balenie v ks 🚚	1 000		1 000		1 000	



ZVODOVÁ OBJÍMKA S HROTOM 300 mm

P-PODD

Menovitá veľkosť	100		120	
	Bez DPH	S DPH	Bez DPH	S DPH
TM 1 Testa di Moro RAL 8028	4,55	5,46	4,95	5,94
	002402		002419	
AN 2 Antracit RAL 7016	4,55	5,46	4,95	5,94
	002303		002310	
IC 3 Intenzívna čierna RAL 9005	4,55	5,46	4,95	5,94
	002327		002334	
OC 4 Oceľovo červená RAL 3009	4,55	5,46	4,95	5,94
	002365		002372	
MH 5 Medeno hnedá RAL 8004	4,55	5,46	4,95	5,94
	002341		002358	
SB 6 Šedo biela RAL 9002	4,55	5,46	4,95	5,94
	002389		002396	
Balenie v ks 	20		20	
Balenie v ks 	800		800	



POZINK
POLYESTER



ZVODOVÁ OBJÍMKA M10

P-POB

Menovitá veľkosť	60		80		100		120		150	
	Bez DPH	S DPH	Bez DPH	S DPH	Bez DPH	S DPH	Bez DPH	S DPH	Bez DPH	S DPH
TM 1 Testa di Moro RAL 8028	2,90	3,48	2,65	3,18	2,75	3,30	3,30	3,96	4,90	5,88
	074119		074126		074133		074140		074157	
AN 2 Antracit RAL 7016	2,90	3,48	2,65	3,18	2,75	3,30	3,30	3,96	4,90	5,88
	073471		073488		073495		073501		073518	
IC 3 Intenzívna čierna RAL 9005	2,90	3,48	2,65	3,18	2,75	3,30	3,30	3,96	4,90	5,88
	073679		073686		073693		073709		073716	
OC 4 Oceľovo červená RAL 3009	2,90	3,48	2,65	3,18	2,75	3,30	3,30	3,96	4,90	5,88
	073914		073921		073938		073945		073952	
MH 5 Medeno hnedá RAL 8004	2,90	3,48	2,65	3,18	2,75	3,30	3,30	3,96	4,90	5,88
	073723		073730		073747		073754		073761	
SB 6 Šedo biela RAL 9002	2,90	3,48	2,65	3,18	2,75	3,30	3,30	3,96	4,90	5,88
	074010		074027		074034		074041		074058	
BH 7 Bielo hliníková RAL 9006	2,90	3,48	2,65	3,18	2,75	3,30	3,30	3,96	4,90	5,88
	073570		073587		073594		073600		073617	
PS 8 Prachovo šedá RAL 7037	2,90	3,48	2,65	3,18	2,75	3,30	3,30	3,96	4,90	5,88
	073969		073976		073983		073990		074003	
MM 9 Metalická medená RAL extra	2,90	3,48	2,65	3,18	2,75	3,30	3,30	3,96	4,90	5,88
	073778		073785		073792		073808		077158	
BHT – P.20 10 Bielo hliníková tmavá RAL 9007	2,90	3,48	2,65	3,18	2,75	3,30	3,30	3,96	4,90	5,88
	119711		094537		094544		094551		094674	
MZ 11 Machovo zelená RAL 6005	2,90	3,48	2,65	3,18	2,75	3,30	3,30	3,96	4,90	5,88
	073860		073877		073884		073891		073907	
MOT 12 Tmavo modrá RAL 5010	2,90	3,48	2,65	3,18	2,75	3,30	3,30	3,96	4,90	5,88
	073815		073822		073839		073846		073853	
TZ 13 Trávovo zelená RAL 6011	2,90	3,48	2,65	3,18	2,75	3,30	3,30	3,96	4,90	5,88
	074164 *		074171		074188		074195		074201 *	
Balenie v ks 📦	25		25		25		25		20	
Balenie v ks 🚚	3 000		3 000		3 000		3 000		2 400	

* Výroba na objednávku



ZVODOVÁ OBJÍMKA M8

P-POB





Menovitá veľkosť	60		80		100		120		150	
	Bez DPH	S DPH	Bez DPH	S DPH	Bez DPH	S DPH	Bez DPH	S DPH	Bez DPH	S DPH
TM 1 Testa di Moro RAL 8028	2,90	3,48	2,65	3,18	2,75	3,30	3,30	3,96	4,90	5,88
	074065		074072		074089		074096		074102	
AN 2 Antracit RAL 7016	2,90	3,48	2,65	3,18	2,75	3,30	3,30	3,96	4,90	5,88
	073426		073433		073440		073457		073464	
IC 3 Intenzívna čierna RAL 9005	2,90	3,48	2,65	3,18	2,75	3,30	3,30	3,96	4,90	5,88
	073624		073631		073648		073655		073662	
BH 7 Bielo hliníková RAL 9006	2,90	3,48	2,65	3,18	2,75	3,30	3,30	3,96	4,90	5,88
	073532		073525		073549		073556		073563	
Balenie v ks	25		25		25		25		20	
Balenie v ks	3 000		3 000		3 000		3 000		2 400	



NEREZOVÁ SKRUTKA S PVC PODLOŽKOU M6x20

P-POB-NSK





Menovitá veľkosť	EAN číslo výrobku	Balenie v ks		Cena [€/ks]	
				Bez DPH	S DPH
M6 x 20 *	071675	1	–	0,15	0,18

* Výroba na objednávku

ZÁVITOVÝ HROT TORX M10

P-POB-HT





Menovitá veľkosť	EAN číslo výrobku	Balenie v ks		Cena [€/ks]	
				Bez DPH	S DPH
80	002464	100	40 000	1,00	1,20
140	002471	100	28 000	1,25	1,50
200	002488	100	20 000	1,55	1,86
250	002495	100	16 000	1,70	2,04
300	002501	100	11 200	1,70	2,04

POZINK
POLYESTER

HMOŽDINKA MODRÁ BEZ LAMELY M10

P-POB-HN DB





Menovitá veľkosť	EAN číslo výrobku	Balenie v ks		Cena [€/ks]	
				Bez DPH	S DPH
120	002426	100	25 000	0,40	0,48

HMOŽDINKA MODRÁ S LAMELOU M10

P-POB-HN DB





Menovitá veľkosť	EAN číslo výrobku	Balenie v ks		Cena [€/ks]	
				Bez DPH	S DPH
180	002433	100	12 000	0,42	0,50
240	002440	100	12 000	0,50	0,60
280	002457	100	12 000	0,53	0,64

KOMBISKRUTKA TORX M10

P-POB-ZT/SZ



Menovitá veľkosť	EAN číslo výrobku	Balenie v ks		Cena [€/ks]	
				Bez DPH	S DPH
140	002587	50	10 400	0,45	0,54
180	002594	50	10 400	0,55	0,66

HMOŽDINKA ŠTVORHRANÝ HROT 7x7

P-POB-HN R1



Menovitá veľkosť	EAN číslo výrobku	Balenie v ks		Cena [€/ks]	
				Bez DPH	S DPH
200/60	002600	250	15 000	0,18	0,22

NYLON IZOLAČNÁ HMOŽDINKA S OCHRANNOU KRYTKOU M10

P-POB-HN IZOL



Menovitá veľkosť	EAN číslo výrobku	Balenie v ks		Cena [€/ks]	
				Bez DPH	S DPH
M10 x 96	001207	25	2 625	2,95	3,54

ZÁVITOVÁ TYČ M10

P-POB-ZT



Menovitá veľkosť	EAN číslo výrobku	Balenie v ks		Cena [€/ks]	
				Bez DPH	S DPH
60	002556	100	20 800	0,20	0,24
100	002563	100	15 600	0,30	0,36
150	002570	50	10 400	0,55	0,66

MONTÁŽNA PLATŇA M10

P-POB-ZT MP





Menovitá veľkosť	EAN číslo výrobku	Balenie v ks		Cena [€/ks]	
				Bez DPH	S DPH
80 x 30	002518	25	5 200	1,15	1,38

ZÁVITOVÝ HROT M8

P-POB-HB





Menovitá vel'kost'	EAN číslo výrobku	Balenie v ks		Cena [€/ks]	
				Bez DPH	S DPH
150	071590	100	5 000	0,65	0,78
200	071606	100	5 000	0,92	1,10
250	071613	100	5 000	1,05	1,26
300	071620	100	5 000	1,10	1,32

HMOŽDINKA ŠEDÁ HROTU OBJÍMKY M8

P-POB-HBN-SS

















Menovitá vel'kost'	EAN číslo výrobku	Balenie v ks		Cena [€/ks]	
				Bez DPH	S DPH
150	071637	100	5 000	0,20	0,24
200	071644	100	5 000	0,25	0,30
250	071651	100	5 000	0,25	0,30
300	071668	100	8 000	0,37	0,44

GUMOVÁ FAREBNÁ KRYTKA HROTU OBJÍMKY

P-POB-HT AKG



Menovitá vel'kost'	EAN číslo výrobku	Balenie v ks		Cena [€/ks]	
				Bez DPH	S DPH
 29 x 13	002280	50	16 800	0,25	0,30
 29 x 13	002211	50	16 800	0,25	0,30
 29 x 13	002235	50	16 800	0,25	0,30
 29 x 13	002266	50	16 800	0,25	0,30
 29 x 13	002242	50	16 800	0,25	0,30
  29 x 13	002228	50	16 800	0,25	0,30
   29 x 13	002273	50	16 800	0,25	0,30
 29 x 13	002259	50	16 800	0,25	0,30
 29 x 13	002297	50	16 800	0,25	0,30

ZACHYTÁVAČ VODY

P-PZV



Menovitá veľkosť	80		100		120	
	Bez DPH	S DPH	Bez DPH	S DPH	Bez DPH	S DPH
TM 1 Testa di Moro RAL 8028	12,55	15,06	12,95	15,54	19,00	22,80
	034533		034540		034557	
AN 2 Antracit RAL 7016	12,55	15,06	12,95	15,54	19,00	22,80
	034410		034427		034434	
IC 3 Intenzívna čierna RAL 9005	12,55	15,06	12,95	15,54	19,00	22,80
	034441		034458		034465	
OC 4 Oceľovo červená RAL 3009	12,55	15,06	12,95	15,54	19,00	22,80
	034502		034519		034526	
MH 5 Medeno hnedá RAL 8004	12,55	15,06	12,95	15,54	19,00	22,80
	034472		034489		034496	
Balenie v ks	6		5		3	
Balenie v ks	180		150		90	

ZACHYTÁVAČ VODY+SITKO

P-PZVS





Menovitá veľkosť	80		100		120	
	Bez DPH	S DPH	Bez DPH	S DPH	Bez DPH	S DPH
TM 1 Testa di Moro RAL 8028	12,55	15,06	12,95	15,54	19,00	22,80
	034861		034878		034885	
AN 2 Antracit RAL 7016	12,55	15,06	12,95	15,54	19,00	22,80
	034564		034571		034588	
IC 3 Intenzívna čierna RAL 9005	12,55	15,06	12,95	15,54	19,00	22,80
	034625		034632		034649	
OC 4 Oceľovo červená RAL 3009	12,55	15,06	12,95	15,54	19,00	22,80
	034779		034786		034793	
MH 5 Medeno hnedá RAL 8004	12,55	15,06	12,95	15,54	19,00	22,80
	034656		034663		034670	
SB 6 Šedo biela RAL 9002	12,55	15,06	12,95	15,54	19,00	22,80
	034830		034847		034854	
BH 7 Bielo hliníková RAL 9006	12,55	15,06	12,95	15,54	19,00	22,80
	034595		034601		034618	
PS 8 Prachovo šedá RAL 7037	12,55	15,06	12,95	15,54	19,00	22,80
	034809		034816		034823	
MM 9 Metalická medená RAL extra	12,55	15,06	12,95	15,54	19,00	22,80
	034687		034694		034700	
BHT – P.20 10 Bielo hliníková tmavá RAL 9007	12,55	15,06	12,95	15,54	19,00	22,80
	095718		095725		095732	
MZ 11 Machovo zelená RAL 6005	12,55	15,06	12,95	15,54	19,00	22,80
	034748		034755		034762	
MOT 12 Tmavo modrá RAL 5010	12,55	15,06	12,95	15,54	19,00	22,80
	034717		034724		034731	
TZ 13 Trávovo zelená RAL 6011	12,55	15,06	12,95	15,54	19,00	22,80
	034892 *		034908		034915	
Balenie v ks 📦	6		5		3	
Balenie v ks 🚚	180		150		90	

* Výroba na objednávku

HLINÍKOVÝ ZACHYTÁVAČ VODY+HADICA

P-PZVHA

Menovitá veľkosť	80		100		120	
	Bez DPH	S DPH	Bez DPH	S DPH	Bez DPH	S DPH
TM 1 Testa di Moro RAL 8028	65,00	78,00	65,00	78,00	133,50	160,20
	018793		018809		018816	
AN 2 Antracit RAL 7016	65,00	78,00	65,00	78,00	133,50	160,20
	018496		018502		018519	
IC 3 Intenzívna čierna RAL 9005	65,00	78,00	65,00	78,00	133,50	160,20
	018557		018564		018571	
OC 4 Oceľovo červená RAL 3009	65,00	78,00	65,00	78,00	133,50	160,20
	018700		018717		018724 *	
MH 5 Medeno hnedá RAL 8004	65,00	78,00	65,00	78,00	133,50	160,20
	018588 *		018595		018601 *	
SB 6 Šedo biela RAL 9002	65,00	78,00	65,00	78,00	133,50	160,20
	018762 *		018779		018786	
BH 7 Bielo hliníková RAL 9006	65,00	78,00	65,00	78,00	133,50	160,20
	018526		018533		018540	
PS 8 Prachovo šedá RAL 7037	65,00	78,00	65,00	78,00	133,50	160,20
	018731 *		018748		018755 *	
MM 9 Metalická medená RAL extra	65,00	78,00	65,00	78,00	133,50	160,20
	018618 *		018625 *		018632 *	
BHT – P.20 10 Bielo hliníková tmavá RAL 9007	65,00	78,00	65,00	78,00	133,50	160,20
	095527 *		095534 *		095541 *	
MZ 11 Machovo zelená RAL 6005	65,00	78,00	65,00	78,00	133,50	160,20
	018670 *		018687		018694 *	
MOT 12 Tmavo modrá RAL 5010	65,00	78,00	65,00	78,00	133,50	160,20
	018649 *		018656 *		018663 *	
TZ 13 Trávovo zelená RAL 6011	65,00	78,00	65,00	78,00	133,50	160,20
	018823 *		018830 *		018847 *	
Balenie v ks 	1		1		1	
Balenie v ks 	60		60		60	

* Výroba na objednávku



OCHRANNÁ RÚRA S REVÍZNYM OTVOROM

P-POZR



Menovitá veľkosť	80		100		100	
	1,0		1,0		1,5	
Dĺžka v m	1,0		1,0		1,5	
Cena v €/m	Bez DPH	S DPH	Bez DPH	S DPH	Bez DPH	S DPH
TM 1 Testa di Moro RAL 8028	64,00	76,80	49,00	58,80	97,00	116,40
	010254 *		010261		010278	
AN 2 Antracit RAL 7016	64,00	76,80	49,00	58,80	97,00	116,40
	009760 *		009777		009784 *	
IC 3 Intenzívna čierna RAL 9005	64,00	76,80	49,00	58,80	97,00	116,40
	009869 *		009876		009883 *	
OC 4 Oceľovo červená RAL 3009	64,00	76,80	49,00	58,80	97,00	116,40
	010117 *		010124 *		010131 *	
MH 5 Medeno hnedá RAL 8004	64,00	76,80	49,00	58,80	97,00	116,40
	009913 *		009920 *		009937 *	
SB 6 Šedo biela RAL 9002	64,00	76,80	49,00	58,80	97,00	116,40
	010209 *		010247 *		010216 *	
BH 7 Bielo hliníková RAL 9006	64,00	76,80	49,00	58,80	97,00	116,40
	009814 *		009821 *		009838 *	
PS 8 Prachovo šedá RAL 7037	64,00	76,80	49,00	58,80	97,00	116,40
	010162 *		010179 *		010186 *	
MM 9 Metalická medená RAL extra	64,00	76,80	49,00	58,80	97,00	116,40
	009968 *		009975 *		009982 *	
BHT – P.20 10 Bielo hliníková tmavá RAL 9007	64,00	76,80	49,00	58,80		
	096494 *		096500 *			
MZ 11 Machovo zelená RAL 6005	64,00	76,80	49,00	58,80	97,00	116,40
	010063 *		010070 *		010087 *	
MOT 12 Tmavo modrá RAL 5010	64,00	76,80	49,00	58,80	97,00	116,40
	010018 *		010025 *		010032 *	
TZ 13 Trávovo zelená RAL 6011	64,00	76,80	49,00	58,80	97,00	116,40
	010308 *		010315 *		010322 *	
Balenie v ks	1		1		1	
Balenie v ks	70		60		60	

* Výroba na objednávku

OCHRANNÁ RÚRA S REVÍZNYM OTVOROM



P-POZR

Menovitá veľkosť	120		120	
	Dĺžka v m		1,5	
Cena v €/m	Bez DPH	S DPH	Bez DPH	S DPH
	TM 1 Testa di Moro RAL 8028	115,00	138,00	165,00
	010285		010292 *	
AN 2 Antracit RAL 7016	115,00	138,00	165,00	198,00
	009791 *		009807 *	
IC 3 Intenzívna čierna RAL 9005	115,00	138,00	165,00	198,00
	009890 *		009906 *	
OC 4 Oceľovo červená RAL 3009	115,00	138,00	165,00	198,00
	010148 *		010155 *	
MH 5 Medeno hnedá RAL 8004	115,00	138,00	165,00	198,00
	009944 *		009951 *	
SB 6 Šedo biela RAL 9002	115,00	138,00	165,00	198,00
	010223 *		010230 *	
BH 7 Bielo hliníková RAL 9006	115,00	138,00	165,00	198,00
	009845 *		009852 *	
PS 8 Prachovo šedá RAL 7037	115,00	138,00	165,00	198,00
	010193 *		009753 *	
MM 9 Metalická medená RAL extra	115,00	138,00	165,00	198,00
	009999 *		010001 *	
BHT – P.20 10 Bielo hliníková tmavá RAL 9007	115,00	138,00		
	096517 *			
MZ 11 Machovo zelená RAL 6005	115,00	138,00	165,00	198,00
	010094 *		010100 *	
MOT 12 Tmavo modrá RAL 5010	115,00	138,00	165,00	198,00
	010049 *		010056 *	
TZ 13 Trávovo zelená RAL 6011	115,00	138,00	165,00	198,00
	010339 *		010346 *	
Balenie v ks 	1		1	
Balenie v ks 	40		40	

* Výroba na objednávku

OBJÍMKA S REBROVOU GUMOU M10

P-POB-OZR

Menovitá veľkosť	EAN číslo výrobku	Balenie v ks		Cena [€/ks]	
				Bez DPH	S DPH
80	002525	25	1 250	1,55	1,86
100	002532	25	1 250	2,00	2,40
120	002549	20	1 000	2,25	2,70



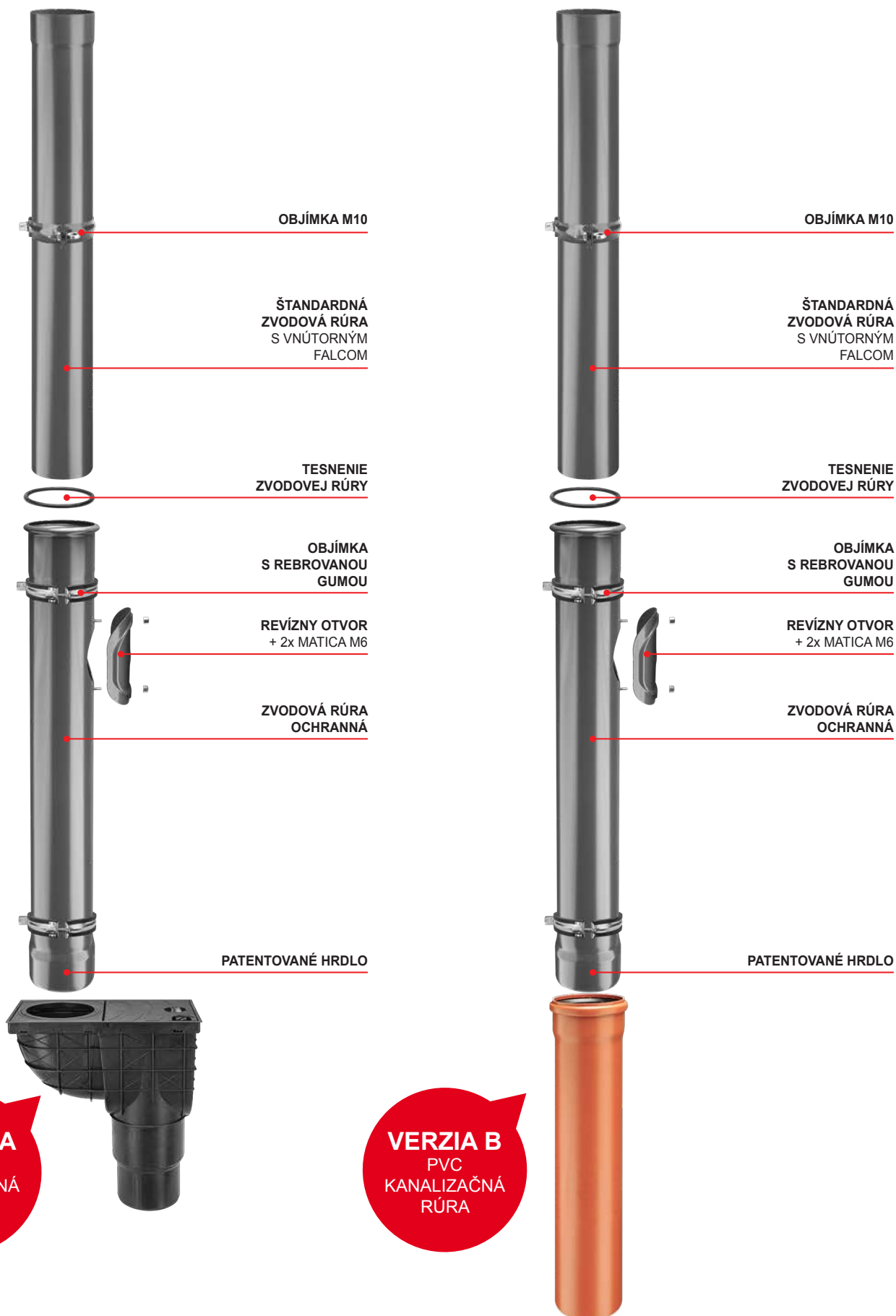

POZINK
POLYESTER

